

S & R FASTENER CO., INC.

PHILLIPS PAN HEAD TAPPING SCREW WHITE HEAD



(100 per box)

**COMING
SOON**

PART	SIZE	PART	SIZE
115501*	6 x 5/8	115522	10 x 1
115502*	6 x 3/4	115523*	10 x 1-1/4
115505	6 x 1	115524	10 x 1-1/2
115510	8 x 1/2	115530	12 x 1/2
115511*	8 x 3/4	115531	12 x 3/4
115512	8 x 1	115532*	12 x 1
115520*	10 x 1/2	115533	12 x 1-1/4
115521	10 x 3/4	115534*	12 x 1-1/2

* - Coming Soon



1177
16 Ga. Trailer Wire Spool
PVC Primary 4-Wire
Color Coded and Jacketed
Meets SAE J1128
105°C (221°F)
100ft. Spool
Box Qty. 1



222537
Splash Shield Assortment
24 Varieties
355 Pieces
Includes 99904 Large Drawer
Box Qty. 1

222324
Metric 10.9 Fastener Assortment
40 Varieties
1465 Pieces
Includes #99815 Bin
Box Qty. 1



222325
Metric 10.9 Fastener Assortment
40 Varieties
1465 Pieces
NO BIN - FASTENERS ONLY
Box Qty. 1

BMW



270071
Zinc & Yellow
U Type Nut
3.5mm (#6) Screw Size
PR: .5mm - 1.5mm
Center Hole To Edge: 8mm
BMW, Mercedes
Box Qty. 50



292002
16-13-1-176-747,
003-990-02-51
Black Nylon
Nylon Flange Nut
Stud Size: 5mm
Hex: 10mm
Flange Dia: 16mm
Overall Height: 11mm
BMW & Mercedes 1997 - UP
Box Qty. 25



295273
51-13-8-124-389
Black Plastic
(Use with 416112)
Cowl Panel Mldg Insert
Head Dia: 13mm
Stem Length: 11mm
Stem Dia: 9mm
BMW Series 3 & 5 '89 - UP
Box Qty. 50



295274
51-44-7-780-15,
108-988-00-27
Natural Nylon
Tubular Nut
Stud Size: 7mm
Head Dia: 16mm
Stem Length: 16mm
Fits Into 8.5mm Hole
BMW, Mercedes, Universal
Box Qty. 25



416112
51218-205-295
Black Nylon
(Use with 295273)
Cowl Vent
Push-Type Retainer
Head Dia: 20mm
Stem Length: 16mm
Fits Into 7mm (9/32") Hole
BMW Series 5 '97 - UP
Box Qty. 50



416297
Black Nylon
Bumper &
Wheel Opening
Push-Type Retainer
Head Dia: 15mm
Stem Length: 15mm
Fits Into 6.3mm Hole
BMW 2004 - UP
Box Qty. 15



416303
17-11-1-712-963
Black Nylon
Bumper Side
Support & Fan Shroud
Push-Type Retainer
Head Dia: 15mm
Stem Length: 11mm
Fits Into 8mm Hole
BMW 3, 5, 7, 8, X, Z Series & i8
1990 - UP
Mini-Cooper 2007 - 2010
Box Qty. 25



435009
51-71-8-259-025
Black & White Nylon
Wheel Flare & Rocker
Moulding Clip
Top Head: 20mm x 30mm
Grommet Head Dia: 12mm
Grommet Stem Dia: 7.4mm
Grommet Length: 15mm
BMW 7 Series 1998 - 2001
X Series 2011 - UP
Box Qty. 25

S & R FASTENER CO., INC.



435418
51-13-1-960-054
White Nylon
With Rubber Boot
Moulding Clip
Width: 22mm
Length: 35mm
Hole Size: 10mm
BMW 1992 - 1999
Box Qty. 25



435419
51-13-2-251-394
White Nylon
With Rubber Boot
Moulding Clip
Width: 18mm
Length: 30.5mm
Stem Length: 10mm
Hole Size: 10mm
BMW 1992 - 1999
Box Qty. 25



435420
51-13-8-166-675
White Nylon
With Rubber Boot
Moulding Clip
Width: 25.5mm
Length: 34mm
Stem Length: 11mm
Hole Size: 9.5mm
BMW 1995 - 2003
Box Qty. 25



435421
51-13-8-231-130
White Nylon
With Rubber Boot
Moulding Clip
Width: 20.5mm
Length: 32mm
Stem Length: 9.5mm
BMW 3 Series 1991 - 2009
Box Qty. 25

CHRYSLER



302003
6509799-AA
Zinc Organic
Metric Extruded U-Nut
Screw Size: M4.8-1.6 (#10)
Panel Range: .61mm - 3.8mm
(.024" - .149")
Center of Hole to Edge:
11.5mm (.452")
Chrysler 200 & Pacifica and Dodge
Dart & Ram and Jeep Cherokee
2010 - UP
Box Qty. 25

302036
W520822-S439, 6510185-AA,
6101956, 6503694
Zinc Organic
Metric Extruded U-Nut
Screw Size: M6-1.0
Panel Range: .8mm - 4.0mm
(.030" - .160")
Center of Hole to Edge: 13.5mm (17/32")
Chrysler 300, Pacifica, Prowler, PT Cruiser, Sebring & Town &
Country and Dodge Caravan, Challenger, Charger, Durango,
Magnum, Nitro, Ram, Stratus & Viper and Jeep Commander,
Grand Cherokee & Wrangler 1996 - UP
Box Qty. 25



FORD



200011
W704875-S439
Zinc Organic
M4.2-1.41 x 19mm
Hex Washer
Head Tapping Screw
Hex: 7mm
Washer Dia: 12.5mm
Ford Escape, Explorer, Edge,
Expedition, F-150/250/350/450/550,
Flex, Taurus & Thunderbird and
Lincoln LS, Mark LT, MKX & MKZ
1999 - UP
Box Qty. 25



302006
W716567-S439
Zinc Organic
Metric U-Nut
Screw Size: M4.2-1.41
Panel Range: 1.8mm-3.5mm
(.071" - .137")
Center of Hole to Edge:
9.5mm (3/8")
Ford Escape & Lincoln MKC
2013 - UP
Box Qty. 25



416290
480534, 384051-S
Black Nylon
Head Dia: 13/32 x 1"
Stem Dia: 9/32"
Stem Length: 9/16"
Cowl Insulation Retainer
GM
Splash Shield/ Wire Retainer
Ford
Box Qty. 25

GM



200281
11609457
Black Zinc
M4.2-1.41 x 20mm
Round Washer Hd
Pozi-Drive Tap Screw
Head Dia: 11mm
Tail Lamp Assembly
Buick Cascada, Enclave, Encore,
Cadillac CTS, Chevrolet Avalanche,
Camaro, Caprice, Corvette, Impala,
Monte Carlo & Trax and Pontiac G6
2000 - UP
Box Qty. 25



216358
11589031
Black Zinc
Class 9.8
Hex Head Sems
Body Bolt
M6-1.0 x 20mm
Hex: 10mm
Washer Dia: 24mm
Front Bumper Support,
Fender Liner, Grille &
Headlamp Adjusting
Cadillac Escalade, Chevrolet
Camaro, Silverado, GMC Sierra and
Pontiac Solstice 2006 - UP
Box Qty. 15

















270004
11570015
Zinc Organic
Front/Rear Bumper &
Headlamp Assembly
Specialty Push-In Nut
Thread Size: M6-1.0
Overall Height: 11.6mm
Buick Cascada, Envision, LaCrosse
& Regal, Cadillac ATS, CT6, CTS,
ELR, Escalade & XTS, Chevrolet
Camaro, Colorado, Cruze, Malibu,
Silverado, Sonic, Suburban, Tahoe &
Volt and GMC Acadia 2011 - UP
Box Qty. 10



292007
25704358
White Nylon
Rear Bumper
Screw Grommet With Sealer
Screw Size: M6.3 (1/4" or #14)
Head: 15mm x 18mm
Stem Length: 23mm
Cadillac CTS & SRX and
Pontiac Grand Prix 2004 - UP
Box Qty. 10

S & R FASTENER CO., INC.

<p>302004 11548579 Zinc Organic Metric Extruded U-Nut Screw Size: M4.2-1.41 (#8) Panel Range: 2.0mm - 3.0mm (.078" - .118") Center of Hole to Edge: 9.5mm (3/8") <i>Buick Cascada, Encore, Envision, LaCrosse, Cadillac ATS, CTS, XTS, Chevrolet Camaro, Cruze, Equinox, Malibu, Sonic, Traverse, Trax & GMC Terrain 2017 - UP</i> Box Qty. 25</p> 	<p>302005 11548580 Zinc Organic Metric Extruded U-Nut Screw Size: M4.2-1.41 (#8) Panel Range: .65mm - 3.8mm (.026" - .149") Center of Hole to Edge: 15mm (19/32") <i>Cadillac XTS and Conv/Camaro, Chevrolet Cruze, Equinox, & Traverse 2017 - UP</i> Box Qty. 25</p> 	<p>302037 11611321 Zinc Organic Metric Extruded U-Nut Screw Size: M6-1.0 Panel Range: .70mm - 2.0mm Center of Hole to Edge: 14mm <i>Buick Envision, LaCrosse, Cadillac XTS, Chevrolet Bolt EV, Colorado, Cruze, Equinox, Impala, Traverse, Volt & GMC Acadia Canyon & Terrain 2017 - UP</i> Box Qty. 10</p> 	<p>416290 480534, 384051-S Black Nylon Head Dia: 13/32 x 1" Stem Dia: 9/32" Stem Length: 9/16" Cowl Insulation Retainer <i>GM</i> Splash Shield/ Wire Retainer <i>Ford</i> Box Qty. 25</p> 
<p>420005 24405740 Blue Nylon Windshield Pillar, Interior & Trunk Trim Moulding Clip w/ Metal Reinforcement Top Hd: 17mm x 20mm Bottom Hd: 14mm x 28mm Stem Length: 11mm <i>Buick Allure, Encore, Lacrosse, Regal & Verano, Cadillac XTS, Chevrolet Camaro, Caprice, Cruze, Malibu & Sonic 2010 - UP</i> Box Qty. 15</p> 	<p>420006 24405739 Black Nylon Windshield Pillar, Interior Trim Moulding Clip w/ Metal Reinforcement Top Hd: 17mm x 20mm Bottom Hd: 14mm x 28mm Stem Length: 12mm <i>Buick Allure, Encore, Lacrosse, Regal & Verano, Cadillac XTS, Chevrolet Camaro, Caprice, Cruze, Malibu & Sonic 2010 - UP</i> Box Qty. 15</p> 	<p>420007 11611623 Blue Nylon Windshield Pillar, Interior Trim Moulding Clip w/ Metal Reinforcement Top Hd: 17mm x 24mm Bottom Hd: 14mm x 28mm Stem Length: 10mm <i>Cadillac ATS & Escalade, Chevrolet Corvette, Impala & Malibu, GMC Sierra & Yukon 2013 - UP</i> Box Qty. 10</p> 	<p>420008 11547026 Red Nylon Windshield Garnish, Interior Trim Moulding Clip w/ Metal Reinforcement Top Hd: 17mm x 24mm Bottom Hd: 14mm x 28mm Stem Length: 10mm <i>Cadillac ATS & CTS, Chevrolet Impala, GMC Yukon 2013 - UP</i> Box Qty. 10</p> 
<p>420009 11611367 Blue Nylon Scuff Plate & Trim Panel Moulding Clip w/Sealer & Metal Reinforcement Top Hd: 17mm x 24mm Bottom Hd: 10mm x 24mm Stem Length: 10mm Overall Height: 16mm <i>Buick Verano, Cadillac ATS, CTS & XTS, Chevrolet Camaro, Impala, Malibu & Volt 2011 - UP</i> Box Qty. 10</p> 	<p>420011 11547024 Red Nylon Door Sill Plate Moulding Clip w/Sealer & Metal Reinforcement Top Hd: 17mm x 24mm Bottom Hd: 10mm x 24mm Stem Length: 10mm Overall Height: 16mm <i>Cadillac ELR & XTS 2013 - UP Chevrolet Camaro & Malibu 2016 - UP</i> Box Qty. 10</p> 		
<h2>HONDA / ACURA</h2>			
<p>295276 91626-STK-A01 Gray Nylon Taillight Screw Grommet with Sealer Head Dia: 18mm Stem Length: 14mm Overall Length: 16mm <i>Acura MDX & RDX and Honda Accord, Civic, Crosstour & Odyssey 2007 - UP</i> Box Qty. 25</p> 	<p>416298 91563-TG7-A00 Black Nylon Weatherstrip Retainer Head Dia: 12mm Stem Dia: 8mm Stem Length: 10mm <i>Acura NSX 2017 - UP Honda CR-V, Pilot & Ridgeline 2016 - UP</i> Box Qty. 100</p> 	<p>435003 91560-TG1-T01 Green Nylon Garnish Retainer w/Sealer Top Head: 13mm Middle Head: 16.5mm Bottom Head: 18mm Stem Dia: 9.3mm Stem Length: 12mm <i>Honda Accord, Civic, CR-V, Fit, HR- V, Odyssey & Pilot 2013 - UP</i> Box Qty. 15</p> 	<p>435006 91560-TL0-G21 Tan Nylon Garnish Retainer w/Sealer Top Head: 13mm Middle Head: 16.5mm Bottom Head: 18mm Stem Dia: 9mm Stem Length: 9mm <i>Acura RDX, TSX, ILX, RLX & TLX and Honda Accord, CR-V & Odyssey 2007 - UP</i> Box Qty. 15</p> 

S & R FASTENER CO., INC.

 <p>435007 90666-SDA-A01 White Nylon Grille Clip Width Across Center Ears: 9mm Width Across Bottom Ears: 11mm Overall Height: 16.5mm <i>Acura RDX, ILX, TL & TSX and Honda Accord, Civic, CR-V, Fit, Odyssey & Pilot 2003 - UP</i> Box Qty. 25</p>	 <p>435008 90651-TA0-003 Natural Nylon Door Panel & Weatherstrip Retainer Top Head: 5mm x 12mm Bottom Head Dia: 12mm Stem Dia: 6mm Stem Length: 4.5mm <i>Acura ILX, MDX, RDX, RLX & ZDX 2010 - UP</i> <i>Honda Accord, CR-V, Pilot & Ridgeline 2008 - UP</i> Box Qty. 50</p>	 <p>445804 90651-T2M-003 Black Nylon Weatherstrip Retainer Head: 4mm x 10mm Stem Dia: 6.5mm Stem Length: 7mm <i>Honda Accord & Clarity 2014 - UP</i> Box Qty. 25</p>	
--	--	---	--













HYUNDAI

 <p>38519 Dia: 3.2mm (1/8") Grip: 4.0mm - 7.9mm (.158" - .311") Flange Dia: 6.3mm (1/4") Black Aluminum Rivet Steel Mandrel Front/Rear Bumper <i>Hyundai Accent, Azera, Elantra, Equus, Santa Fe, Santa Fe Sport, Tuscon, Veracruz & Kia Optima, Rondo, Sorento & Soul 2007 - UP</i> Box Qty. 25</p>	 <p>200000 12210-06203, 12342-06203 Black Zinc M6-1.0 x 19mm Phillips Round Head Thread Cutting Screw with Sems® Flat & Lock Washer Flat Washer Dia: 13mm Lock Washer Dia: 11mm <i>Hyundai Elantra, Genesis, Scoupe, Santa Fe & Tiburon 1990 - 2014</i> Box Qty. 50</p>	 <p>200001 12291-06303 Black Zinc M6-1.0 x 29mm Phillips Round Head License Plate Screw with Sems® Flat & Lock Washer Flat Washer Dia: 13mm Lock Washer Dia: 11mm <i>Hyundai Equus 2010 - 2015</i> <i>Genesis 2008 - 2014</i> Box Qty. 25</p>	 <p>292003 97519-22000 White Nylon Bumper & Side Marker Lamp Screw Grommet w/Sealer Screw Size: M3.5 (#6) Head Dia: 14mm Stem Length: 16mm Fits Into 7mm x 7mm Hole <i>Hyundai Accent, Elantra, Excel, Santa Fe, Scoupe, Sonata, Tiburon, Tuscon & Veloster 1985 - UP</i> Box Qty. 50</p>
--	---	--	---

 <p>292004 86699-1E010 Gray Nylon Bumper Screw Grommet Screw Size: M4.8 (#10) Head Size: 12mm x 12mm Stem Length: 8mm Overall Height: 10mm <i>Hyundai Accent, Tucson & Veloster 2009 - UP</i> <i>Kia Optima & Optima Hybrid 2010 - 2013</i> Box Qty. 25</p>	 <p>292005 14910-04000, 92561-25000 Natural Nylon License Plate Grommet Screw Size: M3.5 (#6) Head Dia: 12mm Stem Length: 7mm Overall Height: 9mm <i>Hyundai Accent, Azera, Elantra, Entourage, Excel, Ioniq, Santa Fe, Scoupe, Tiburon, Tucson, Veloster, XG300 & XG350 1985 - UP</i> <i>Kia Optima & Rio 2010 - 2016</i> Box Qty. 25</p>	 <p>292122 84145-26000 Black Nylon Wheel Well Liner & Splash Shield Nylon Nut Hex Size: 14mm Flange Dia: 30mm Overall Height: 10mm <i>Hyundai Accent, Elantra, Equus, Genesis, Genesis Coupe, Genesis G90, Santa Fe, Sonata, Tucson, Veloster & Veracruz 2000 - UP</i> Box Qty. 15</p>	 <p>292123 86625-1E000 White Nylon Bumper Bracket Screw Grommet With Sealer Screw Size: M4.8 (#10) Top Head: 14mm x 18mm Bottom Head Dia: 18mm Stem Size: 8.5mm x 8.5mm Stem Length: 18mm <i>Hyundai Elantra GT 2013 - UP</i> <i>Kia Niro & Sorento 2016 - UP</i> Box Qty. 25</p>
---	--	---	---

 <p>415999 0B102-68865 Black Nylon Trunk Trim Retainer Head Dia: 20mm Stem Dia: 7mm Stem Length: 13mm <i>Hyundai Accent, Genesis & Tucson 2005 - 2017</i> <i>Kia Rio, Rondo, Sedona, Sorento, Soul & Sportage 2000 - 2017</i> Box Qty. 25</p>	 <p>416302 86590-1W000 Black Nylon Bumper Cover Push-Type Retainer Head Dia: 18mm Stem Length: 11mm Fits Into 8mm Hole <i>Hyundai Equus & Genesis 2014 - 2016</i> <i>Kia Rio & Sedona 2012 - UP</i> Box Qty. 25</p>	 <p>435473 85818-37000 White Nylon Moulding Clip With Sealer Top Head: 12.5mm x 14mm Bottom Head Dia: 16mm Stem Dia: 10mm Stem Length: 12.5mm <i>Hyundai Accent, Elantra & Tucson and Kia Optima & Rio 2012 - UP</i> Box Qty. 25</p>	 <p>435474 87715-3S000 White Nylon Waist Line Moulding Trim Clip With Sealer Head Size: 5mm x 14mm Stem Size: 5mm x 11mm Stem Length: 9mm <i>Hyundai Sonata & Sonata Hybrid 2009 - UP</i> Box Qty. 25</p>
---	---	---	---

S & R FASTENER CO., INC.

 <p>445861 82134-22000 Black Nylon Door Weatherstrip Clip Height: 14mm Length: 20mm <i>Hyundai Accent, Elantra, Santa Fe, Sonata, Tucson & Veloster 1993 - UP</i> <i>Kia Forte 2014 - 2017</i> Box Qty. 25</p>	 <p>445862 82134-3L000 Black Nylon Weatherstrip Clip Width: 12mm Length: 18mm <i>Hyundai Azera, Elantra, Equus, Genesis, Santa Fe & Sonata and Kia Optima & Sedona 2005 - 2017</i> Box Qty. 50</p>	 <p>465000 86143-3S000 White Nylon Windshield Moulding Clip Overall Length: 60mm <i>Hyundai Sonata 2011 - 2015</i> Box Qty. 25</p>	
KIA			
 <p>38519 Dia: 3.2mm (1/8") Grip: 4.0mm - 7.9mm (.158" - .311") Flange Dia: 6.3mm (1/4") Black Aluminum Rivet Steel Mandrel Front/Rear Bumper <i>Hyundai Accent, Azera, Elantra, Equus, Santa Fe, Santa Fe Sport, Tuscon, Veracruz & Kia Optima, Rondo, Sorento & Soul 2007 - UP</i> Box Qty. 25</p>	 <p>292004 86699-1E010 Gray Nylon Bumper Screw Grommet Screw Size: M4.8 (#10) Head Size: 12mm x 12mm Stem Length: 8mm Overall Height: 10mm <i>Hyundai Accent, Tucson & Veloster 2009 - UP</i> <i>Kia Optima & Optima Hybrid 2010 - 2013</i> Box Qty. 25</p>	 <p>292005 14910-04000, 92561-25000 Natural Nylon License Plate Grommet Screw Size: M3.5 (#6) Head Dia: 12mm Stem Length: 7mm Overall Height: 9mm <i>Hyundai Accent, Azera, Elantra, Entourage, Excel, Ioniq, Santa Fe, Scoupe, Tiburon, Tucson, Veloster, XG300 & XG350 1985 - UP</i> <i>Kia Optima & Rio 2010 - 2016</i> Box Qty. 25</p>	 <p>292123 86625-1E000 White Nylon Bumper Bracket Screw Grommet With Sealer Screw Size: M4.8 (#10) Top Head: 14mm x 18mm Bottom Head Dia: 18mm Stem Size: 8.5mm x 8.5mm Stem Length: 18mm <i>Hyundai Elantra GT 2013 - UP</i> <i>Kia Niro & Sorento 2016 - UP</i> Box Qty. 25</p>
 <p>415999 0B102-68865 Black Nylon Trunk Trim Retainer Head Dia: 20mm Stem Dia: 7mm Stem Length: 13mm <i>Hyundai Accent, Genesis & Tuscon 2005 - 2017</i> <i>Kia Rio, Rondo, Sedona, Sorento, Soul & Sportage 2000 - 2017</i> Box Qty. 25</p>	 <p>416302 86590-1W000 Black Nylon Bumper Cover Push-Type Retainer Head Dia: 18mm Stem Length: 11mm Fits Into 8mm Hole <i>Hyundai Equus & Genesis 2014 - 2016</i> <i>Kia Rio & Sedona 2012 - UP</i> Box Qty. 25</p>	 <p>435473 85818-37000 White Nylon Moulding Clip With Sealer Top Head: 12.5mm x 14mm Bottom Head Dia: 16mm Stem Dia: 10mm Stem Length: 12.5mm <i>Hyundai Accent, Elantra & Tucson and Kia Optima & Rio 2012 - UP</i> Box Qty. 25</p>	 <p>445861 82134-22000 Black Nylon Door Weatherstrip Clip Height: 14mm Length: 20mm <i>Hyundai Accent, Elantra, Santa Fe, Sonata, Tucson & Veloster 1993 - UP</i> <i>Kia Forte 2014 - 2017</i> Box Qty. 25</p>
 <p>445862 82134-3L000 Black Nylon Weatherstrip Clip Width: 12mm Length: 18mm <i>Hyundai Azera, Elantra, Equus, Genesis, Santa Fe & Sonata and Kia Optima & Sedona 2005 - 2017</i> Box Qty. 50</p>			

S & R FASTENER CO., INC.

LEXUS

416299

90467-07220

Black Nylon
Bumper Cover, Radiator Support,
Under Cover & Wheel Opening
Push-Type Retainer

Head Dia: 20mm

Stem Length: 12mm

Fits into 7mm Hole

Lexus CT 200h, GX 460, IS 300, IS 350, LC 500h, NX 200t, NX 300h,
RX 350 & RX 450h and Toyota 4Runner, C-HR, Camry, Corolla,
Corolla iM, Prius, Prius Prime, Prius V & RAV4 2013 - UP

Scion iM, iC & xB 2008 - 2016

Box Qty. 25



416304

90467-07208

Black Nylon
Fender Seal Retainer

Head Dia: 16mm

Stem Dia: 8mm

Stem Length: 16mm

Fits Into 8mm Hole

Lexus ES 300h, ES 350, IS F,
LS 460 & LS 600h 2013 - UP

Box Qty. 25



416305

90467-09242

Black Nylon
Cowl Grille

Push-Type Retainer

Head Dia: 22mm

Stem Length: 15mm

Fits into 9mm Hole

Lexus RX 350 & RX 450h and
Toyota C-HR, Camry, Prius, Prius
Prime & Yaris 2016 - UP

Box Qty. 15



MAZDA

435540

KD45-51-W24

White Nylon

Fender & Wheel Apron
Moulding Clip With Sealer

Top Head: 14mm x 18mm

Bottom Head Dia: 18mm

Stem Length: 12mm

Stem Dia: 11mm

Mazda CX-5 2013 - 2016

Box Qty. 25



MERCEDES

270071

Zinc & Yellow

U Type Nut

3.5mm (#6) Screw Size

PR: .5mm - 1.5mm

Center Hole To Edge: 8mm

BMW, Mercedes

Box Qty. 50



270072

123-994-08-45

Zinc & Yellow

U Type Nut

4.2mm (#8) Screw Size

PR: .5mm - 2.5mm

Center Hole To Edge: 14mm

Mercedes

Box Qty. 25



292002

16-13-1-176-747,

003-990-02-51

Black Nylon

Nylon Flange Nut

Stud Size: 5mm

Hex: 10mm

Flange Dia: 16mm

Overall Height: 11mm

BMW & Mercedes 1997 - UP

Box Qty. 25



292008

639-998-01-85,

000-988-16-25

Nylon

Cowl Vent Nut

M3.5 (#6) Screw Size

Head: 9.5mm x 9.5mm

Stem Length: 14mm

Fits Into 6.5mm x 7mm Hole

Mercedes

Box Qty. 25



295274

51-44-7-780-15,

108-988-00-27

Natural Nylon

Tubular Nut

Stud Size: 7mm

Head Dia: 16mm

Stem Length: 16mm

Fits Into 8.5mm Hole

BMW, Mercedes, Universal

Box Qty. 25



415711

000-990-37-92

Black Nylon

Trunk Trim &

General Purpose

Push-Type Retainer

Head Dia: 13mm

Stem Length: 14mm

Fits Into 8mm Hole

Mercedes SL500 & SL600

Convertible '99 - UP

Box Qty. 15



416292

000-990-44-92

Black Nylon

Push-Type Retainer

Head Dia: 12mm

Stem Length: 11mm

Fits Into 5mm x 5mm Hole

Mercedes

Box Qty. 25



416293

000-990-40-92,

124-990-05-92-9051

Black Nylon

Push-Type Retainer

Head Dia: 12mm

Stem Length: 11mm

Fits Into 5mm Hole

Mercedes



Box Qty. 25



S & R FASTENER CO., INC.



 <p>416294 000-990-46-92 Black Nylon Push-Type Retainer Head Dia: 17mm Stem Length: 15mm Fits Into 6mm Hole Mercedes Box Qty. 10</p>	 <p>416295 124-990-04-92 Black Nylon Push-Type Retainer Head Dia: 16mm Stem Length: 18mm Fits Into 7mm Hole Mercedes 2003 - UP Box Qty. 15</p>	 <p>416296 000-990-84-92 Black Nylon Push-Type Retainer Head Dia: 10mm Stem Length: 10mm Fits Into 6mm Hole Mercedes 2005 - UP Box Qty. 25</p>	 <p>421007 000-988-86-25 Natural Nylon Rocker Panel Moulding Screw Grommet Stem Length: 16mm Flange Dia: 18mm Use with M4.2 (#8) Screw Mercedes CL, E, & S '96 - UP Box Qty. 25</p>
--	--	--	---

NISSAN

 <p>445802 01553-0162U White Nylon Liftgate, Pillar & Quarter Panel Trim Retainer Top Head Dia: 13mm Middle Head Dia: 16mm Bottom Head Dia: 18mm Stem Dia: 10mm Stem Length: 14mm Overall Length: 21mm Nissan Frontier, Maxima, Murano, Pathfinder & Xterra 2007 - UP Box Qty. 25</p>	 <p>475711 65625-8J000 Black Nylon Hood Release Cable Clip Holds 6mm Dia. Cable Fits into 6mm Hole Nissan Altima, Maxima, Murano, NV1500, NV2500, NV3500, Pathfinder, Rogue, Sentra, Versa & Versa Note 2016 - UP Box Qty. 50</p>		
---	---	--	--



TOYOTA

 <p>292006 90189-06238 Neon Yellow Nylon Headlamp Assembly Grommet Screw Size: M4.8 (#8) Head Dia: 17mm Stem Length: 8mm Fits into 9mm x 9mm Hole Toyota C-HR, Camry, Prius C & Prius Prime 2017 - UP Box Qty. 25</p>	 <p>416299 90467-07220 Black Nylon Bumper Cover, Radiator Support, Under Cover & Wheel Opening Push-Type Retainer Head Dia: 20mm Stem Length: 12mm Fits into 7mm Hole Lexus CT 200h, GX 460, IS 300, IS 350, LC 500h, NX 200t, NX 300h, RX 350 & RX 450h and Toyota 4Runner, C-HR, Camry, Corolla, Corolla iM, Prius, Prius Prime, Prius V & RAV4 2013 - UP Scion iM, iC & xB 2008 - 2016 Box Qty. 25</p>	 <p>416305 90467-09242 Black Nylon Cowl Grille Push-Type Retainer Head Dia: 22mm Stem Length: 15mm Fits into 9mm Hole Lexus RX 350 & RX 450h and Toyota C-HR, Camry, Prius, Prius Prime & Yaris 2016 - UP Box Qty. 15</p>
---	--	---

 <p>421008 90467-22014 Black Nylon Rocker Moulding Retainer with Sealer Head Dia: 38mm Stem Length: 11mm Fits into 22mm Hole Toyota Camry 2018 - UP Prius & Prius Prime 2016 - UP Box Qty. 10</p>	 <p>421009 90467-22015 Black Nylon Rocker Moulding Retainer with Sealer Head Dia: 47mm Stem Length: 35mm Fits into 22mm Hole Toyota Camry 2018 - UP Prius & Prius Prime 2016 - UP Box Qty. 10</p>	 <p>421011 75867-68010 White Nylon Rocker Panel & Wheel Opening Moulding Retainer Top Head Dia: 13mm Bottom Head Dia: 18mm Stem Length: 14.5mm Stem Dia: 9.5mm Toyota C-HR, Camry, Prius, Prius C, Prius Prime, Prius V & RAV4 2012 - UP Box Qty. 50</p>	
---	---	--	--

S & R FASTENER CO., INC.

VW

 <p>416291 <i>N90-796-501,</i> <i>N90-796-502</i> Dacromet Radiator Support & Splash Shield Push-On Retainer Stud Size: 5mm OD: 30mm <i>VW 1999 - 2006</i> Box Qty. 25</p>	 <p>416301 <i>6N0-129-355</i> Black Nylon Bumper Clamping Washer Outside Dia: 18mm Thickness: 1mm Hole Dia: 5.5mm <i>Audi Q3, Q5, SQ5 & TT</i> <i>2000 - 2017</i> <i>Volkswagen CC, Passat & Touareg</i> <i>2004 - 2010</i> Box Qty. 25</p>		

S & R FASTENER CO., INC.

S & R FASTENER CO., INC.

S & R FASTENER CO., INC.

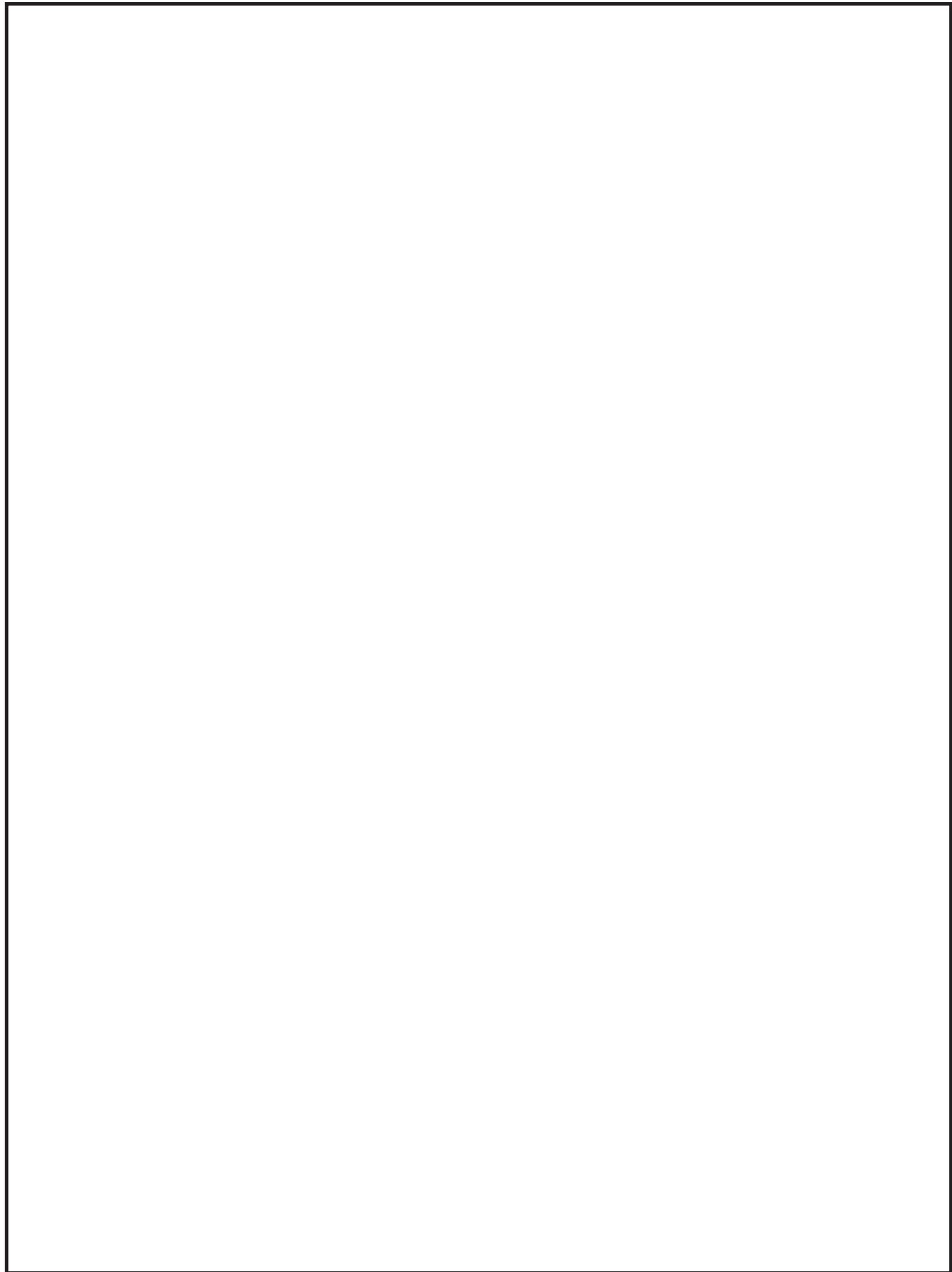

S & R FASTENER CO., INC.

S & R FASTENER CO., INC.

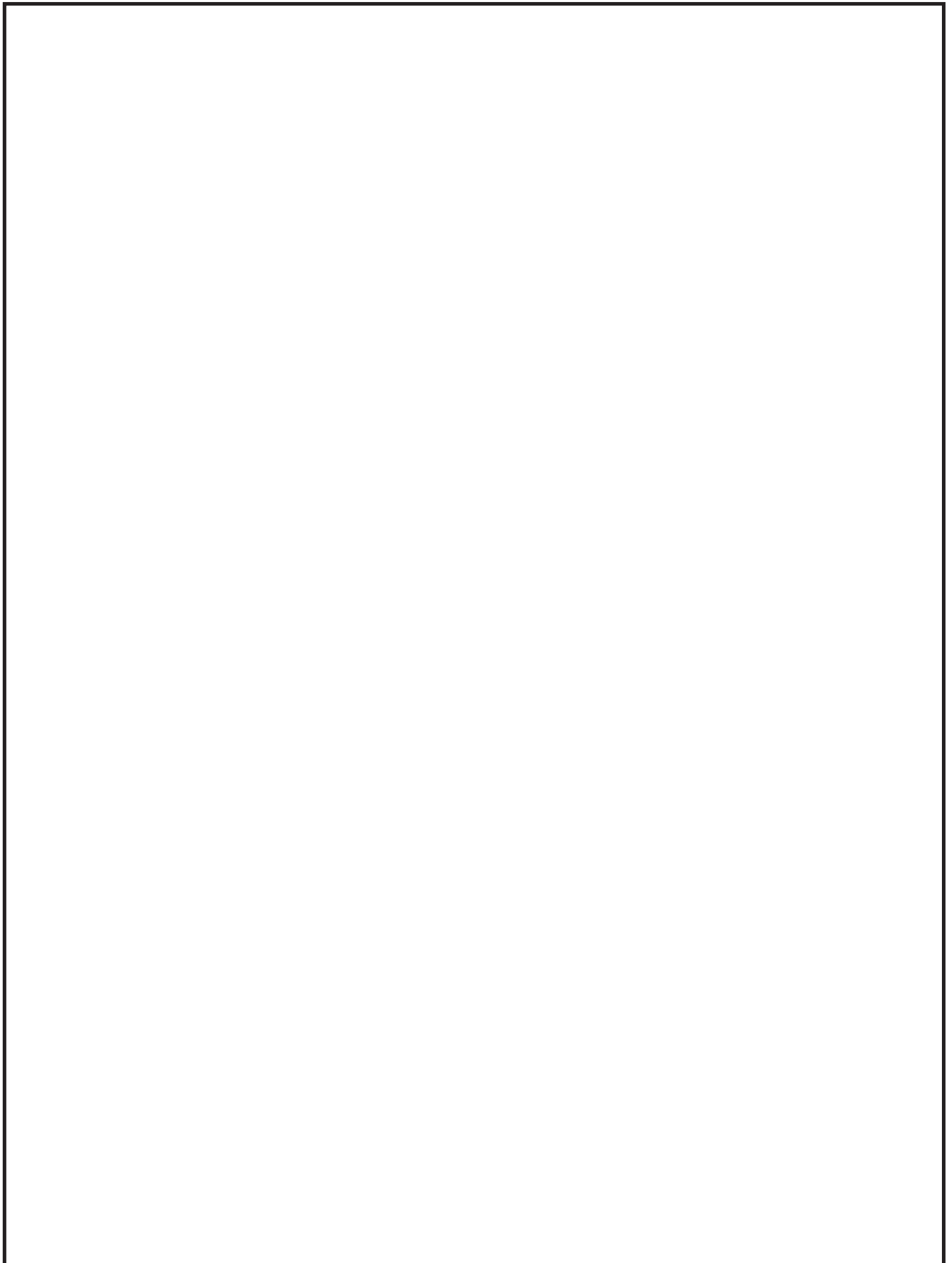

S & R FASTENER CO., INC.

S & R FASTENER CO., INC.

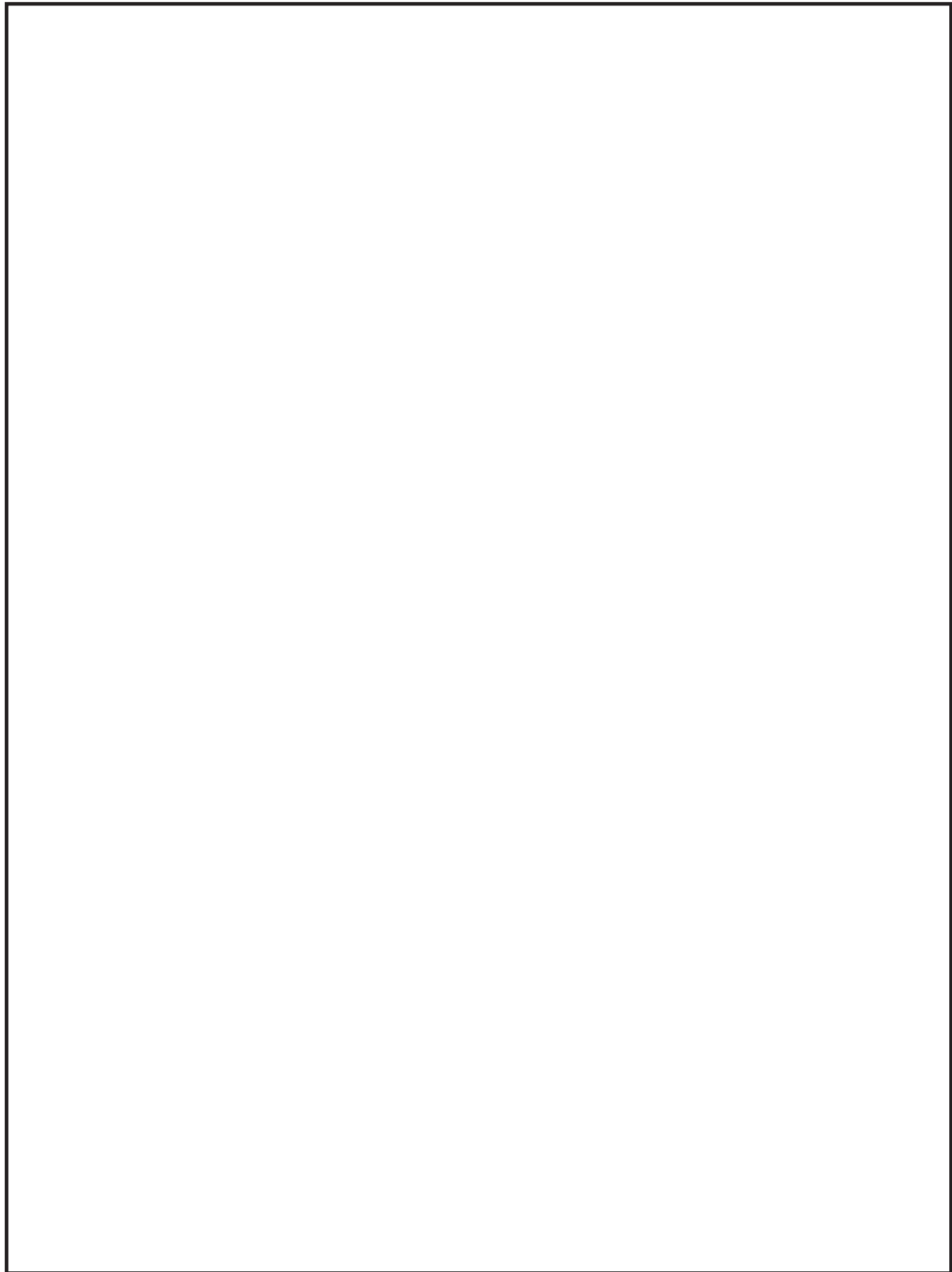

S & R FASTENER CO., INC.

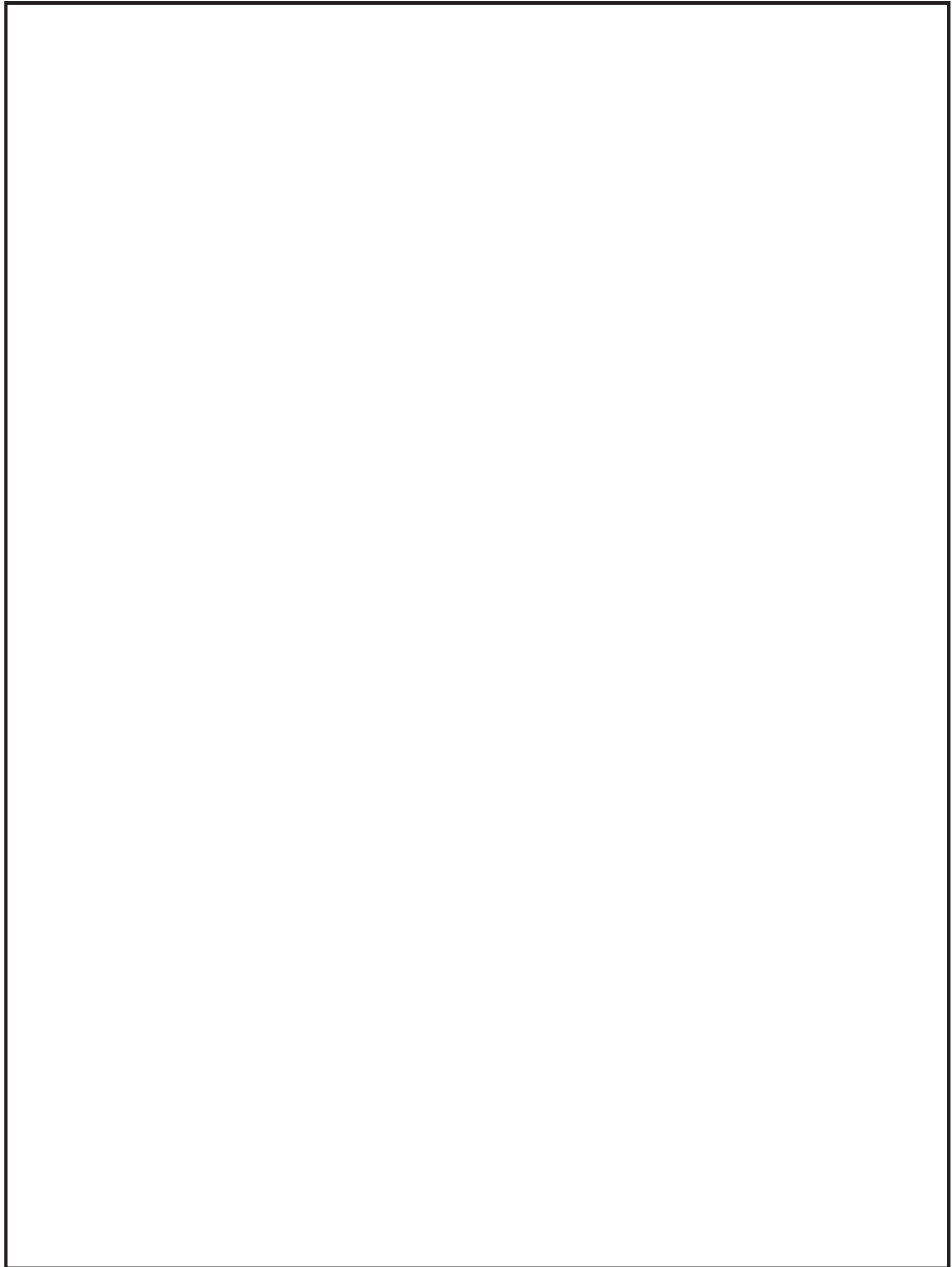

S & R FASTENER CO., INC.

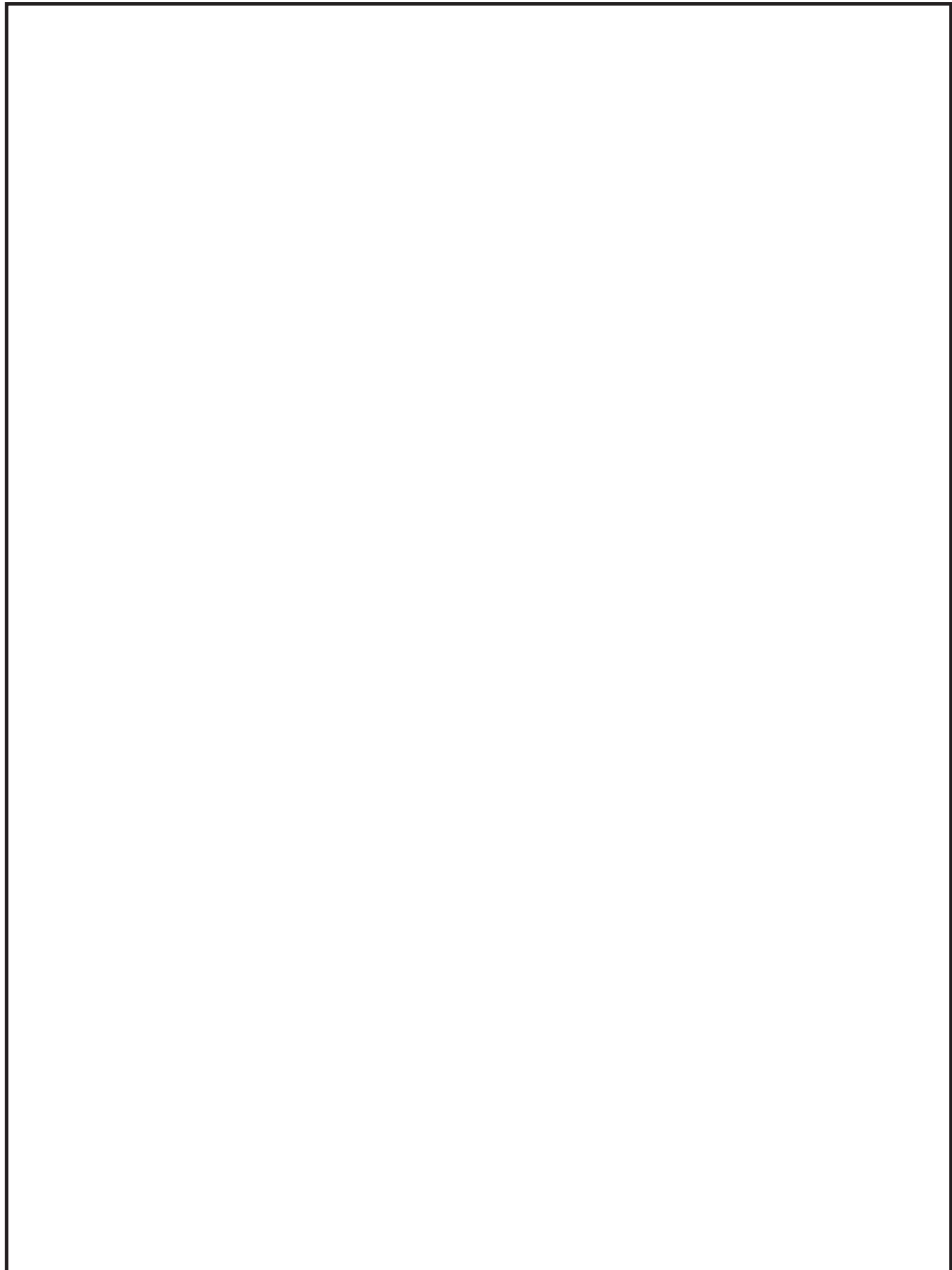

S & R FASTENER CO., INC.

