

















TOYOTA CLIPS

<p>38568 90269-05054 Rivet: M5 Flange: 14mm G.R.: 3 - 8mm Aluminum Rivet with Steel Mandrel & Plastic Seal Gas Filler Door Blind Rivet Toyota Camry '98 - UP Box Qty. 10</p> 	<p>38569 90269-06013 Hole: M6 Rivet: M4.8 Flange: 14mm G.R.: 1.6 - 6.35mm Aluminum Rivet, Steel Mandrel & Plastic Seal Gas Filler Door Blind Rivet Toyota Camry '97 - UP Lexus IS300 2001 Box Qty. 15</p> 	<p>38576 90269-04053 Hole: M4 Rivet: 3.2mm G.R.: 1mm - 4.8mm Flange Dia.: 9mm Aluminum Rivet/ Steel Mandrel w/Nylon Cap Toyota 1998 - UP Box Qty. 10</p> 	<p>38577 75547-51021 Hole: M4 Rivet: 3.2mm G.R.: .8mm - 1.5mm Flange Dia.: 10.5mm Aluminum Rivet Steel Mandrel w/Nylon Cap Toyota 2002 - UP, Box Qty. 15</p> 
<p>38611 90084-26001 Dia.: 5mm Grip: 3.2mm - 6.3mm Flange Dia.: 9.5mm Closed End Sealing Type Rivet Aluminum Rivet & Mandrel Windshield Side Moulding Toyota Camry '97 - UP Box Qty. 50</p> 	<p>38764 90269-A0005 Diameter: 1/4" (6.3mm) Grip: 1/16" - 3/16" (1.6mm - 4.8mm) Flange Dia.: 1/2" (13mm) Black Aluminum Rivet Steel Mandrel Fuel Door & General Purpose Toyota 2007 - UP Box Qty. 10</p> 	<p>200101 Zinc & Yellow Dichromate M6.3-1.81 x 20mm (#14 x 25/32") Hex Head SEMS® Washer OD: 18mm (45/64") Hex: 10mm Honda, Nissan, Toyota Box Qty. 25</p> 	<p>280294 90468-04030 Bumper Strip Retainer Toyota '84 - UP Box Qty. 50</p> 
<p>285115 N811169-S, W705550-S300, 90189-06111 White Nylon Headlamp Mounting / Turn Signal Retainer Head Dia.: 13mm Stem length: 9mm Fits Into 11mm Hole Ford F250-F550 '99 - UP Toyota/Lexus '89 - UP Box Qty. 50</p> 	<p>292040 97606B0700, 75522-611-000, 9991-00-412 Grommet Nut #8 Screw Size 9.5mm Wide, 9.5mm Long Fits into 7mm x 7mm Hole Honda, Toyota, Nissan Box Qty. 50</p> 	<p>292050 90189-05013, MS-480002, 94841764 Nylon Nut Headlamp Bezel & Grille #10 Screw Size 12mm Wide, 12mm Long Fits into 8mm x 9mm Hole G.M. Nova '85 - UP Toyota, Mitsubishi, GM Box Qty. 50</p> 	<p>292057 Box 50 292055 96706-W1000, 90189-06013 Screw Grommet #14 (1/4") or M6.3-1.81 Screw Size Head Dia.: 20mm Stem Length: 17mm Fits Into 8mm x 8mm Hole Toyota Box Qty. 25</p> 
<p>292060 90189-04008, MB029111, 90467-12096 Nylon Grille Nut #8 Screw Size 15mm High, 12mm Wide, 16mm Long Fits In 10mm x 10mm Hole G.M. Nova '85 - UP Toyota, Mitsubishi Box Qty. 25</p> 	<p>292082 90189-06006 Natural Nylon #10 Screw Size Head Diameter: 17mm Fits Into 9mm x 9mm Hole Box Qty. 25</p> 	<p>292083 90189-06214 Black Nylon Fender Liner Screw Grommet #12 (M5.5) Screw Size Head Diameter: 16mm Stem Length: 18mm Sienna, Tacoma & Tundra Pick-Up 1999 - UP Box Qty. 15</p> 	<p>292084 90189-06157 Fender Lining Screw Grommet #12 Screw Size Head Diameter: 20mm Stem Length: 22mm Fits Into 8mm x 8mm Hole Avalon, Camry, Rav 4, Solara & Tacoma 1995-UP Box Qty. 15</p> 

TOYOTA CLIPS

Toyota Clips

30

292085

90189-06065
Hood & Fender
Screw Grommet
M5.5 (#12) Screw Size
Head Diameter: 20mm
Stem Length: 18mm
Fits Into 9mm x 9mm Hole
Camry & RAV 4
1999 - 95
Box Qty. 25



292086

90662-693-003,
90189-04066
Nylon
Screw Grommet
#6 Screw Size
Head Dia.: 14mm
Stem Length: 10mm
Fits Into 7mm x 7mm Hole
Honda Accord '82 - UP,
Toyota
Box Qty. 25



292088

90189-05142
Natural Nylon
Headlight Mounting
Nylon Nut
Screw Size: M4.2 (#8)
Head Diameter: 17mm
Stem Length: 8mm
Fits Into 9mm Square Hole
Toyota & Scion
2001 - UP
Box Qty. 25



292097

90189-04059
White Nylon
Screw Grommet
M3.5 (#6) Screw Size
Head Size: 12mm x 18mm
Stem Length: 7mm
Scion, Avalon & FJ Cruiser
1992 - UP
Box Qty. 25



292108

52197-22020
Black Nylon
Rear Bumper
Side Bracket
Screw Grommet
Head Size: 16mm x 18mm
Stem Length: 19mm
Lexus ES 350 & HS 250H
2007 - 2012
Toyota Avalon & Camry
2012 - UP
Box Qty. 15



292114

52188-06030
Yellow Nylon
Rear Bumper Screw
Grommet With Sealer
Screw Size: M6 (#14)
Head Diameter: 20mm
Stem Length: 22mm
Fits Into 9mm x 9mm
Sq Hole
Toyota Camry 2007 - 11
Box Qty. 15



292207

90189-06193
Natural Nylon
Front Bumper Nut
Head Size: 14mm x 16mm
Use w/ #12 Screw (M5.5)
Stem Length: 10mm
Toyota Camry, Avalon
2002 - UP
Box Qty. 25



292210

90189-06010,
75521-611-0000,
9991-00-601,96706-P0105
Nylon
#10 Screw Size Grommet
13mm Wide, 13mm Long
Snaps Into 8.5mm sq. Hole
Used with 5mm Screws
Toyota, Honda, Mazda,
Nissan
Box Qty. 25



292215

90189-05012,
8941340270
Nylon
Screw Grommet
#6 Screw Size
16mm Wide, 12mm Long
Snaps Into
6mm x 10mm Hole
Used with 3mm Screws
Toyota, Isuzu
Box Qty. 25



292216

90189-06162
Front Clearance Lamp Nut
Toyota Camry '91 - '94
Headlight Adjusting Nut
Lexus
Box Qty. 10



292218

90189-06028
Plastic
Wheel Apron Retainer
Hole: M9 square
Flange: 16mm
Toyota Tacoma, T100 &
4Runner
Box Qty. 15



292220

90189-04011
Nylon
Screw Grommet
#6 Screw Size
12mm Wide, 12mm Long
Snaps Into
7mm x 7.5mm Hole
Used with 3mm Screws
Box Qty. 25



292225

90672-671-8110M1,
90189-04013
Nylon Screw Grommet
#6 Screw Size
Head Dia.: 14mm
Stem Length: 15mm
Fits Into 7mm x 7mm Hole
Honda & Toyota
Box Qty. 25



292240

90189-04019
Nylon
Screw Grommet
#8 Screw Size
14mm Long, 12mm Wide
Fits Into
6.5mm x 8.5mm Hole
Used with 4mm Screws
Toyota
Box Qty. 25



292255

90189-04014
Nylon
Screw Grommet
#8 Screw Size
10mm Wide, 10mm Long
Snaps Into
7mm x 7mm Hole
Toyota
Box Qty. 50



292260

90189-06001,
MB098145,
01281-00023
Nylon
Screw Grommet
#10 Screw Size
Head Dia.: 18mm
Stem Length: 17mm
Fits Into
8.5mm x 8.5mm Hole
Toyota, Mitsubishi, Nissan
Box Qty. 25



TOYOTA CLIPS

<p>292270 90189-06042 90661-SC7-0030, H001-50-841, MS-480012, 01651-00481 Nylon Screw Grommet #8 Screw Size Head Dia.: 16mm Stem Length: 17mm Fits a 8mm x 8mm Hole Honda, Toyota, Nissan, Mitsubishi, Mazda Box Qty. 25</p> 	<p>292285 90189-06018 Nylon Screw Grommet #10 Screw Size 14mm Wide, 14mm Long Snaps Into 9mm x 9mm Hole Used with 5mm Screws Toyota Box Qty. 25</p> 	<p>292425 90189-06114 White Nylon Front Fender Liner Screw Grommet Use with M5.5 (#12) Screw Head Dia.: 18mm Stem Length: 15mm Fits into 9mm Square Hole Toyota RAV 4 '96 - 2002 Box Qty. 15</p> 	<p>295285 90467-05012 Plastic Name Plate & Emblems Tubular Nut Retainer Hole: M6 Toyota Box Qty. 25</p> 
<p>302055 Box 25</p>  <p>302044 53789-14010A Plastic Inner Fender U-Nut 5mm Hole Toyota, Lexus Box Qty. 10</p>	 <p>302045 90467-00002 Plastic Fender Attaching Clip 6mm Hole Toyota Box Qty. 10</p>	 <p>302052 90467-05114 Black Nylon U- Nut Bumper/Fender Apron M5.5 (#12) Screw Size 20mm Wide, 36mm Long Panel Range: Up To 1mm Center Hole to Edge: 14mm Lexus, Toyota 2000 - UP Box Qty. 10</p>	 <p>355020 Headlight Mounting Clip Toyota Camry, RAV 4 2001 - UP Lexus IS300 2001 - UP Box Qty. 4</p>
 <p>355145 81195-89101 Headlamp Adjusting Assembly Screw w/ Nut M5 x 50mm Toyota Pickup '84 - UP Box Qty. 10</p>	 <p>355160 81124-89101 Plastic Headlamp Spacer Hole: M7 Toyota Pickup '84 - UP Box Qty. 25</p>	 <p>415234 90467-A0008 Black Nylon Bumper Cover Retainer Toyota, Lexus & Scion 1995 - UP Box Qty: 50</p>	 <p>415240 90467-12078 Black Nylon Retaining Clip Honda & Toyota Box Qty. 25</p>
 <p>415255 E7GZ-6120586-B, G031-58-762, 67868-89101, 67867-28030, 67867-89103 Natural Nylon Weather Strip Retainer Toyota 4-Runner 1989-83 Mazda 1996 - UP Ford 1996 - UP Box Qty. 50</p>	 <p>415260 90467-07050, 01553-00172 Weatherstrip & Trim Panel Clip Head Dia.: 13mm Stem Length: 15mm Panel Thickness: 3mm Fits Into 5mm Hole Toyota, Nissan Box Qty. 50</p>	 <p>415269 90467-06161-01 Nylon Retaining Clip Head Dia.: 14mm Stem Length: 10mm Panel Thickness: 3mm Fits Into 5mm Hole Toyota Box Qty. 25</p>	 <p>415755 10116-41810 Trim Attaching Rivet Toyota Box Qty. 10</p>

TOYOTA CLIPS

<p>415759 Box 50</p> <p>415761 58974-0008, 89421-80270 Nylon Grille Clip 13mm Wide 22mm Long Toyota, Mitsubishi, Honda, Plymouth Laser, Isuzu, Ford Escort Box Qty. 25</p> 	<p>415763 Box 25</p> <p>415762 90467-17004 Nylon Radiator Grille Clip Toyota Cressida '84 - '87 Box Qty. 10</p> 	<p>415860 90467-09145 Nylon Bumper Cover Push-Type Retainer Head Dia.: 15mm Stem Length: 12mm Fits Into 9mm Hole Camry '92 - UP Box Qty. 15</p> 	<p>416050 Box 5 415926 Box 25 415928 Box 50</p> <p>415927 52161-16010 Black Nylon Rear Bumper Cover Push-Type Retainer Head Dia.: 18mm Stem Length: 28mm Fits Into 9mm Hole Toyota Tercel '88 - UP Box Qty. 10</p> 
<p>415930 90467-09008 Black Nylon Hood Insulation Retaining Clip Head Dia.: 30mm Stem Length: 17mm Panel Thickness: 6mm Fits Into 7mm Hole Toyota Cressida, Supra Box Qty. 25</p> 	<p>416019 90467-07059-22 Black Nylon Rear Door Trim & Luggage Compartment Push-Type Retainer Head Dia: 15mm Stem Length: 10mm Fits Into 7mm Hole Toyota Camry & Celica '90 - UP Box Qty. 15</p> 	<p>416020 90467-08122 Natural Nylon Headliner Retaining Clip Head Dia.: 15mm Stem Dia.: 8mm Stem Length: 12mm Toyota Tacoma & T100 '92 - '97 Box Qty. 15</p> 	<p>416022 90467-08124 Black Nylon Hood Insulation Retainer Head Dia.: 25mm Stem Dia.: 8mm Stem Length: 12mm Toyota Supra '93-UP, Lexus '89 - 94 Box Qty. 15</p> 
<p>416028 90467-09096 Black Nylon Front Bumper Push-Type Retainer Head Dia.: 15mm Stem Length: 27mm Fits Into 9mm Hole Toyota Celica, Supra '89 - UP Lexus LS400 '93 - UP Box Qty. 10</p> 	<p>416031 90467-09050 Black Nylon Hood Insulation Retainer Head Dia.: 25mm Stem Length: 10mm Fits Into 7mm Hole Lexus Toyota Camry & Solara '98 - '00 Box Qty. 15</p> 	<p>416051 90467-05090-B1 Black Nylon Bumper Fascia Push-Type Retainer Head Dia: 10mm Stem Length: 12mm Fits Into 5mm Hole Toyota Corolla, Matrix & Scion 2008 - UP Box Qty. 25</p> 	<p>416055 MB888869, 90505-SL0-003, 90467-08155 Plastic Rivet Bumper Cover Hole: M8 Stem: 20.5mm Panel: 13mm, HD: 20mm Chrysler, Mitsubishi, Acura, Toyota '93 - UP Box Qty. 15</p> 
<p>416083 90467-09139 Black Nylon Bumper Cover & Wheel Housing Push-Type Retainer Head Dia.: 18mm Stem Length: 15mm Fits Into 9mm Hole Honda, Mazda & Toyota Corolla '92 - UP Box Qty. 15</p> 	<p>416098 62955-20020 Nylon Retainer with Sealer Head Dia.: 15mm Stem Length: 9mm Fits Into 8mm Hole Toyota Pick-Up Truck Box Qty. 25</p> 	<p>416103 90467-06017, 9926-50-625 Nylon Push-Type Retainer Head Dia.: 15mm Stem Length: 12mm Fits Into 7mm Hole Toyota, Mazda Box Qty. 15</p> 	<p>416106 90467-07146 Plastic Phillips Head Cowl Grille Drive-Type Rivet Hole: M7 Flange: 16mm P.R.: 3mm Toyota Solara '99 Box Qty. 10</p> 

TOYOTA CLIPS

<p>416108 90467-07043, 80999-05N07 Nylon Push-Type Retainer Head Dia.: 18mm Stem Length: 11mm (Not Including The Pin) Fits Into 7mm Hole Toyota, Nissan Box Qty. 15</p> 	<p>416109 90467-05063-C0 Black Nylon Front Bumper Retainer Head Dia: 11mm Stem Length: 8mm Fits Into 5mm Hole Toyota Corolla 2009 - UP Box Qty. 15</p> 	<p>416113 53879-60010 Black Nylon Fender Liner Retainer Head Dia: 18mm Stem Length: 7mm Fits Into 7mm Hole Toyota Land Cruiser, RAV 41998 – UP Lexus Lx470 1998 - UP Box Qty. 15</p> 	<p>416115 Box 50 416117 Box 500</p> <p>416114 90467-07166 Plastic Front Fender Splash Shield Drive-Type Rivet Hole: M7 Flange Dia.: 20mm G.R.: 3mm Toyota Tercel '94 - UP Box Qty. 15</p> 
<p>416116 90467-09004 Plastic Hood Insulation Retainer Hole: M7 Head Dia.: 30mm Stem Length: 16mm Toyota Tacoma '95 - UP Box Qty. 15</p> 	<p>416120 90467-10107 Plastic - Textured Head Fender Splash Shield Clip Hole: M8 Head Dia.: 17mm Stem Length: 11mm Toyota Truck '88 - UP Box Qty. 10</p> 	<p>416122 90467-06175 Black Nylon Luggage Compartment Retainer Head Dia.: 16mm Stem Dia.: 6mm Stem Length: 16mm Toyota Solara '98 - '99 Box Qty. 15</p> 	<p>416124 90467-10077 Butterscotch Nylon Door Moulding Clip with Sealer Head Size: 15mm Square Stem Length: 9mm Fits Into 8mm Hole Toyota Avalon & Corolla '98 - '00 Box Qty. 15</p> 
<p>416128 67921-32010 White Nylon Scuff Plate Retainer Small Head Dia.: 13mm Large Head Dia.: 18mm Stem Length: 11mm Fits Into 9mm Hole Toyota Avalon, Camry & Corolla '97 - '00 Box Qty. 15</p> 	<p>416129 90467-09006 Black Nylon Hood Insulation Retainer Head Dia.: 30mm Stem Length: 17mm Fits Into 7mm Hole Toyota, Lexus '88 - UP Box Qty. 15</p> 	<p>416141 75392-35200, 75392-04010 Blue Nylon Fender Flare & Bumper Clip Head Size: 13mm x 26mm Stem Length: 24mm Toyota Camry, FJ, RAV 4 & Tacoma 2005 - UP Box Qty. 15</p> 	<p>416143 Box 100 416145 Box 25</p> <p>416142 90467-07164 Fender Splash Shield Rivet Hole: M7 Flange: 20mm Stem Length: 10mm Toyota '97 - UP Box Qty. 10</p> 
<p>416147-50 Bx 50</p> <p>416147 90467-07201 Black Nylon Engine Under Cover Push-Type Retainer Head Dia.: 20mm Stem Length: 10mm Fits Into 7mm Hole Toyota Avalon, Camry, Solara 2002 - UP Lexus ES300/330 Box Qty. 10</p> 	<p>416149 90467-08186 Black Nylon Luggage Compartment Trim Retainer Toyota Camry 1999 - UP Box Qty. 15</p> 	<p>416151 52161-20010 Black Nylon Bumper Cover & Grille Push-Type Retainer Head Dia: 18mm Stem Length: 31mm Fits Into 9mm Hole Toyota 2000 - UP Box Qty. 15</p> 	<p>416165 75867-AA010 Black Nylon Rocker Panel & Scuff Plate Retainer Lexus ES300 & ES330 Toyota Avalon, Camry, Scion & Solara 2004 – UP Box Qty. 15</p> 





TOYOTA CLIPS

 <p>416167 90467-07188 Black Nylon Push-Type Retainer Head Diameter: 15mm Stem Length: 17mm Fits Into 7mm Hole Camry, Tundra & 4-Runner 2002 - UP Box Qty. 15</p>	 <p>416173 47749-58010 (use with #416174) Front Fender & Bumper Cover Pin Retainer Head Diameter: 15mm Stem Length: 25mm Lexus and Toyota 4 Runner, Highlander, Sienna & Solara 2000 - UP Box Qty. 10</p>	 <p>416174 53879-58010 (use with #416173) Front Fender & Bumper Cover Clip Width: 25mm Length: 34mm Lexus and Toyota 4 Runner, Highlander, Sienna & Solara 2000 - UP Box Qty. 5</p>	 <p>416176 90467-10183 Black Nylon Front Fender Liner Push-Type Retainer Head Diameter: 18mm Stem Length: 7.5mm Fits Into 7mm Hole Celica, Corolla, Matrix & Solara, Lexus and Pontiac Vibe 1999 - UP Box Qty. 10</p>
 <p>416178 90467-07044 Black Nylon Quarter Panel Wheel Opening Moulding Push-Type Retainer Head Diameter: 20mm Stem Length: 9mm Fits Into 7mm Hole T-100 1992 - UP Box Qty. 10</p>	 <p>416188 90467-09166 Black Nylon Push-Type Retainer Head Diameter: 20mm Stem Length: 9mm Fits Into 9mm Square Hole Camry 2006 - UP Box Qty. 15</p>	 <p>416189 90467-07192 Black Nylon Cowl Vent Push-Type Retainer Head Diameter: 15mm Stem Length: 14mm Fits Into 7mm Hole Toyota RAV 4 2002 - UP Box Qty. 15</p>	 <p>416191 53326-08010 Black Nylon Hood Insulation Retainer Hole Size: 17/64" (7mm) Head Dia.: 24mm Stem Length: 12mm Toyota Sienna 2009 - UP Box Qty. 25</p>
 <p>416193 90467-07211 Bumper, Radiator Cover and Grille Push-Type Retainer Head Diameter: 19mm Stem Length: 8mm Fits Into 7mm Hole Lexus IS & LS, Scion Avalon, Camry / Highlander 2005 - UP Box Qty. 10</p>	 <p>416195 90467-07214 Engine Under Cover Push-Type Retainer Head Diameter: 20mm Stem Length: 9mm Fits Into 7mm Hole Toyota Camry, Lexus & Scion 2007 - UP Box Qty. 15</p>	 <p>416197 90467-10146 Black Nylon Cowl Panel Retainer Toyota Sienna Van 1997 - UP Box Qty. 25</p>	 <p>416199 90467-09206 White Nylon Trim Panel Retainer With Sealer Toyota RAV 4 & Tundra 2000 - UP Box Qty. 15</p>
<p>416213 91563-SCV-003, 67867-52010, 67867-0D060 White Nylon, Weatherstrip Ret. Head Size: 5mm x 15mm Bottom Head Diameter: 6.5mm Stem Diameter: 7mm Stem Length: 8.5mm Acura TL and Honda Element, Odyssey & Pilot 2003 - UP, Toyota Echo, Land Cruiser, Prius, Tacoma & Yaris and Lexus GS 450, GX 460 & LX 430 and Scion xA & xD 2000 - UP Box Qty. 25</p> 	 <p>416225 47749-50090 (Use with #416226, 416227) Black Nylon Front Bumper Cover Pin Head: 10mm Stem Lgth: 24mm Lexus GS, IS, LS 2007 - UP Box Qty. 15</p>	 <p>416226 53879-30040 (Use with #416225) Black Nylon Front Bumper Clip Lexus CT200h, HS250h 2010 - UP Toyota Camry 2012 - UP Box Qty. 5</p>	 <p>416264 53935-35020 Black Nylon Bumper Filler Clip Overall Lgth: 30mm Overall Hght: 17mm Toyota 4 Runner 2003 - UP Box Qty. 10</p>





TOYOTA CLIPS

<p>416265 53888-48010 Black Nylon Wheel Opening Push-Type Retainer Head Diameter: 18mm Stem Length: 14mm Fits Into 7mm Hole Toyota Highlander 2001 - UP Box Qty. 5</p> 	<p>416288 90080-46327 Black Nylon Fender Apron Seal Retainer Head Diameter: 17mm Stem Length: 15mm Fits Into 7mm Hole Toyota Sequoia, Tacoma & Tundra 2000 - UP Box Qty. 50</p> 	<p>416325 53145-60030 Black Nylon Front Bumper, Grille & Hood Seal, Retaining Clip Head Size: 4.3mm x 11mm Stem Diameter: 6.2mm Stem Length: 10mm Toyota Avalon, Camry, Highlander, Land Cruiser, Prius & Venza and Lexus GS 350, GS 450h, IS 250, IS 350, LX 570, NX 200t, NX 300h, RX 350 & RX 450h and Scion iQ & tC 2008 - UP Box Qty. 100</p> 	
<p>435439 75498-42010 White Nylon Garnish Clip Head Dia: 20mm Stem Length: 20mm Toyota RAV 4 '96 - UP Box Qty. 10</p> 	<p>435479 90189-06003 Nylon Screw Grommet #14 (1/4") or M6.2-1.81 Screw Size Head Dia.: 18mm Stem Length: 21mm Fits Into 8mm x 8mm Hole Toyota Box Qty. 25</p> 	<p>435480 90189-06005, 098-145, 01281-00023 Body Moulding Clip M6.3 Screw Toyota, Mitsubishi, Datsun Box Qty. 25</p> 	<p>435483 90467-11063 Plastic Rocker Panel Moulding Clip Hole: M9 Toyota Previa '90 - UP Box Qty. 15</p> 
<p>435484 90904-67036 Blue Nylon Fender Moulding Clip Head Dia.: 17mm Stem Length: 17mm Toyota Highlander, Land Cruiser, Tacoma & Tundra 2001 - '02 Box Qty. 10</p> 	<p>435486 90904-67037 Red Nylon Fender Moulding Clip Head Dia.: 17mm Stem Length: 13mm Toyota Highlander, Land Cruiser, Tacoma & Tundra 2001 - '02 Box Qty. 10</p> 	<p>435487 90467-11100 Yellow Nylon Fender & Wheel Flare Moulding Clip Head Dia.: 17mm Stem Length: 17mm Toyota Highlander, Land Cruiser, Tacoma & Tundra 2000 - '02 Box Qty. 10</p> 	<p>435488 75867-30110 Rocker Panel Mldg. Clip Head: 18mm Stem Length: 22mm Fits Into 9mm Hole Toyota '97 - UP Lexus '97 - 2001 Box Qty. 15</p> 
<p>435491 75397-35010 Orange Nylon Wheel Flare Moulding Clip with Sealer Head Dia.: 17mm Stem Length: 17mm Toyota 4-Runner 2003 - UP Box Qty. 10</p> 	<p>435493 75495-35010 Blue Nylon Rocker Moulding Clip with Sealer Head Dia.: 17mm Stem Length: 10mm Toyota 4-Runner 2003 - UP Box Qty. 10</p> 	<p>435494 90467-10161, 94858299, 94178705 Rocker Moulding Retainer Top Head: 13mm O/L: 20mm P/R: 0.7 - 1.6 Fits Into 8.5mm Hole Sienna, Solara, Tercel 1998 - UP Box Qty. 50</p> 	<p>435517 75867-30120 Black Nylon Rocker Moulding Push-Type Retainer Head Diameter: 18mm Stem Length: 19mm Fits Into 8mm Hole Toyota Camry 2007 - UP Box Qty. 15</p> 

TOYOTA CLIPS

 <p>435518 76924-47010 Black Nylon Rocker Panel Moulding Clip Head Size: 43mm x 54mm Overall Height: 26mm Toyota Prius 2009 - UP Box Qty. 5</p>	 <p>435519 75867-02010 Black Nylon Rocker Moulding Retainer Top Head Dia.: 13mm Bottom Head Dia.: 18mm Stem Diameter: 9mm Stem Length: 10mm Toyota Corolla 2009 - UP Box Qty. 25</p>	 <p>435520 90467-06133-CO Black Nylon Rocker Panel Push-Type Retainer Head Diameter: 14mm Stem Length: 8mm Fits Into 6mm Hole 4-Runner 1998 - UP Box Qty. 15</p>	 <p>435521 52115-48040 Gray Nylon Front Bumper Moulding Clip Overall Length: 47mm Stem Length: 8mm Toyota Highlander 2001 - UP Box Qty. 10</p>
 <p>435522 52197-52010 Black Nylon Front Bumper Moulding Clip With Sealer Width: 30mm Overall Height: 25mm Stem Length: 13mm Toyota Highlander 2001 - UP Box Qty. 10</p>	 <p>435523 61118-35010 Black Nylon Front Fender Upper Seal Moulding Clip Head Size: 18mm x 18mm Stem Length: 13mm Fits Into 9mm Hole Toyota FJ Cruiser 2007-UP Box Qty. 15</p>	 <p>435524 52115-0C090 Black Nylon Front Bumper Moulding Clip Head Size: 25mm x 74mm Overall Height: 17mm Stem Length: 15mm Toyota Tundra 2009 - UP Box Qty. 10</p>	 <p>435525 61991-35010 Black Nylon Front Fender/Sheet Metal Upper Seal Moulding Clip Top Head Size: 9mm x 31mm Overall Height: 30mm Toyota FJ Cruiser 2007 - UP Box Qty. 10</p>
 <p>435526 61992-35010 Black Nylon Front Fender/Sheet Metal Upper Seal Moulding Clip Top Head Size: 13mm x 31mm Overall Height: 34mm Toyota FJ Cruiser 2007 - UP Box Qty. 10</p>	 <p>435538 90467-10186 Black Nylon Fender Apron Seal Clip Top Head Size: 9/16" x 13/16" Toyota 2WD & 4WD Truck 1988 - UP Box Qty. 10</p>	 <p>435620 53145-12010 Black Nylon Grille Clip Overall Length: 38mm Toyota Corolla, FJ Cruiser & Tacoma 1993 - UP Box Qty. 15</p>	 <p>435621 75397-42010 White Nylon Moulding Clip With Sealer Top Head Size: 14.5mm x 17mm Bottom Head Size: 12mm x 18mm Stem Length: 9mm Toyota RAV4 2001 - 2005 Box Qty. 25</p>
 <p>435622 90467-08225 White Nylon Moulding Clip w/Sealer Top Head Size: 10mm x 10mm Bottom Hd Dia: 15mm Stem Dia: 8mm x 8mm Stem Length: 8mm Toyota Corolla, Highlander & RAV4 2014 - UP Box Qty. 15</p>	 <p>445814 62581-14020 Natural Nylon Trim Panel Retainer Mazda & Toyota Box Qty. 25</p>	 <p>445815 67771-01010, 67771-12010, 8942264920, 9927-40-825 Door Panel Retainer Top Head Dia.: 13mm Bottom Head Dia.: 18mm Stem Length: 14mm Overall Length: 21mm Fits Into 9mm Hole Toyota Box Qty. 25</p>	 <p>445816 62217-13010 White Nylon Garnish Moulding Retainer Lexus and Toyota Corolla, Matrix & 4 Runner 2003 - UP Box Qty. 25</p>

TOYOTA CLIPS

 <p>445817 67771-12070 Door Panel Rocker Moulding Retainer With Sealer Lexus SC300/400 Toyota Avalon & Corolla 1992 - UP Box Qty. 15</p>	 <p>445818 90467-10161 White Nylon Trim Board Retainer Sienna, Solara & Tercel 1990 - UP Geo Prizm & Pontiac Vibe 1998 - UP Box Qty. 50</p>	 <p>445820 90467-A0005 Door Trim Panel Retainer With Sealer Camry, FJ Cruiser, Highlander, RAV4 & 4-Runner 2001 - UP Box Qty. 15</p>	<p>445889 Box 25</p>  <p>445881 67771-16080 Natural Nylon Door Trim Panel & Back Panel Upper Garnish Retainer Small Head Dia.: 13mm Large Head Dia.: 18mm Stem Diameter: 9mm Stem Length: 14mm Toyota Truck '88 - UP Box Qty. 10</p>
 <p>445885 67771-30070 Natural Nylon Door Trim Panel & Garnish Retainer Small Head Dia: 13mm Large Head Dia: 16mm Stem Diameter: 9mm Stem Length: 11mm Toyota Corolla, Tercel, T-100 & Tacoma, '92 - UP Box Qty. 25</p>	 <p>445886 67771-16120 Gray Nylon Front & Rear Door Trim Panel Retainer Small Head Dia: 13mm Large Head Dia: 19mm Stem Length: 15mm Fits Into a 9mm Hole Toyota Tercel '94 - UP Box Qty. 15</p>	 <p>445887 90467-10188 Turquoise Nylon Trim Panel Retainer Head Dia: 13mm, 16mm & 18mm Stem Length: 14mm Toyota Sienna 2004 - UP Box Qty. 25</p>	 <p>445888 67771-03030 Nylon Door Trim Retainer Head Dia.: 18mm Stem Length: 14mm Overall Length: 21mm Fits Into 8mm Hole Toyota Camry '88 - UP Box Qty. 50</p>
 <p>445891 67771-22010 Blue Nylon Door Panel Retainer Top Head Dia.: 13mm Bottom Head Dia.: 18mm Stem Length: 15mm Overall Length: 21mm Fits Into 8mm Hole Toyota Box Qty. 25</p>	<p>445978 Box 50</p>  <p>445977 90467-08004, 90467-8011 Nylon Hood Seal Retaining Clip Head Dia.: 13mm Stem Length: 11mm Fits Into 5mm Hole Lexus, Toyota Box Qty. 25</p>	 <p>475085 90183-03001 Front Bumper Cushion Clip Toyota '82 - UP Box Qty. 25</p>	 <p>475530 53455-14020 Nylon Hood Prop Rod Clip Holds 8mm Dia. Rod Snaps Into 14mm Hole Box Qty. 15</p>
 <p>475540 53455-33010, 53455-33011 Natural Nylon Hood Prop Rod Clip Holds 9mm Rod Fits Into 10mm Square Hole Toyota Camry '96 - UP Box Qty. 15</p>	 <p>495001 69293-12030 Door Lock Rod Clip Rod Size: 5mm Right (Passenger) Side Lexus ES 300 2001 - 97 Toyota Camry, Celica, Corolla, Echo, Highlander, MR2, RAV4, Tundra and 4-Runner 1994 - UP Box Qty. 10</p>	 <p>495002 69293-12040 Door Lock Rod Clip Rod Size: 5mm Left (Driver) Side Lexus ES 300 2001 - 97 Toyota Camry, Celica, Corolla, Echo, Highlander, MR2, RAV 4, Tundra and 4-Runner 1994 - UP Box Qty. 10</p>	 <p>TR47-P Code Series: 10001-15000 One Key System Toyota Avalon, Camry, Celica, Corolla, RAV4, Sienna, Solara, Tacoma & Tundra 1992 - UP Box Qty. 5</p>

TOYOTA GLASS SHOP SUPPLIES



465050
75545-12030A
Nylon
Windshield Reveal
Moulding Clip
9mm Wide, 26mm Long
Toyota
Box Qty. 50



465070
75546-22021B
Nylon
Windshield Reveal
Moulding Clip
Toyota
Box Qty. 25



465073
75546-12010
Nylon
Windshield Moulding Clip
20mm Wide, 40mm Long
Fits Into 8mm Hole
Box Qty. 10



465076
75548-32010
Nylon
Windshield Mldg Clip
w/ Self Adhesive Backing
14.5mm Wide, 70mm Long
Box Qty. 25

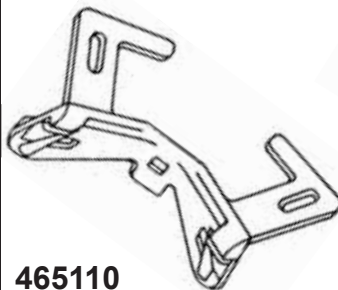

465110
75546-22030
Nylon
Windshield Moulding Clip
Toyota Cressida '81 - '82
Box Qty. 10



465120
75545-16020
Nylon
Windshield Moulding Clip
18mm Wide, 49mm Long,
13mm High
Toyota Corolla, Tercel '83
Box Qty. 10



465129
75545-14060
Plastic
Windshield Moulding Clip
Toyota Celica '82 - '85
Box Qty. 10



465300
75545-12040
Plastic
Windshield Moulding Clip
Toyota Corolla '84 - UP
Box Qty. 25

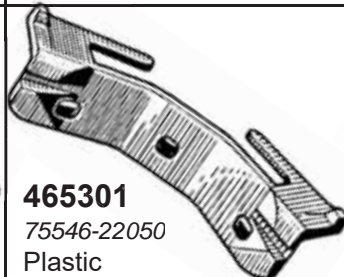

465301
75546-22050
Plastic
Windshield Moulding Clip
14mm Wide, 47mm Long,
12mm High
Toyota Cressida '85 - UP
Box Qty. 25

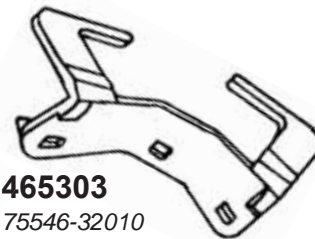

465303
75546-32010
Plastic
Windshield Moulding Clip
20mm Wide, 53mm Long,
16mm High
Toyota Camry '86 - UP
Box Qty. 25

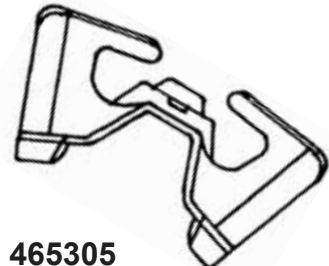

465305
75546-28010
Plastic
Windshield Moulding Clip
Toyota Van '85 - UP
Box Qty. 25

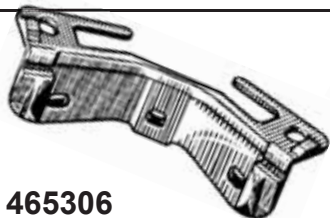

465306
75545-28010-B, 75545-88080
Nylon
Windshield Moulding Clip
18mm Wide, 49mm Long,
16mm High
Toyota Van '84
Box Qty. 25

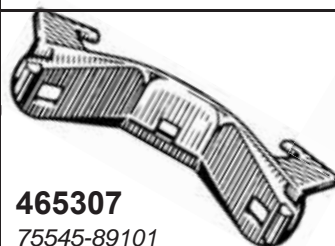

465307
75545-89101
Nylon
Windshield Moulding Clip
15mm Wide, 47mm Long,
13mm High
Toyota Pick-Up Trucks
'84 - UP
Box Qty. 25

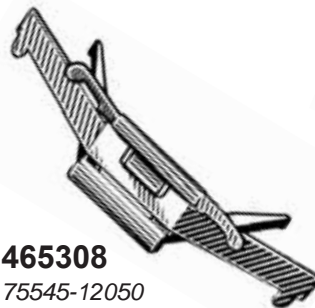

465308
75545-12050
White Plastic
Windshield Moulding Clip
Toyota Corolla '84 - UP
Box Qty. 10



465309
75546-12030
Plastic
Windshield Moulding Clip
21mm Wide, 54mm Long,
15mm High
Toyota Corolla '84 - UP
Box Qty. 10

Toyota Clips

30

TOYOTA GLASS SHOP SUPPLIES

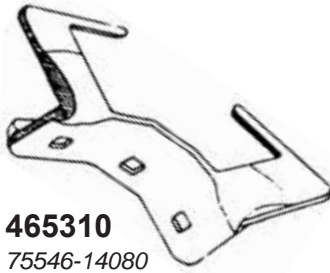

465310

75546-14080
Plastic
Windshield Moulding Clip
Toyota Celica '81 - '87
Box Qty. 25

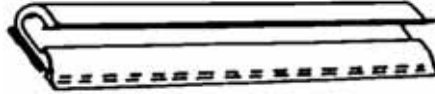

465311

75548-12060
Yellow Plastic
Upper & Side Back Glass
Moulding Clip
Overall Length 60mm
Plastic w/ Self Adhesive
Toyota Corolla '87 - '91
Box Qty. 10



465312

75547-32010
Yellow Plastic
Upper & Side
Back Glass
Moulding Clip
Toyota Camry '87 - UP
Box Qty. 15

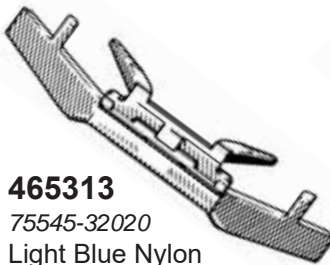

465313

75545-32020
Light Blue Nylon
Windshield Moulding Clip
12mm Wide, 66mm Long
Toyota Tercel,
Camry '87 - UP
Box Qty. 25

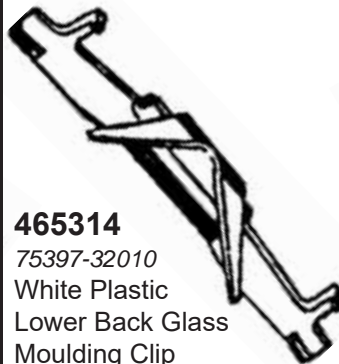

465314

75397-32010
White Plastic
Lower Back Glass
Moulding Clip
Toyota Camry '87 - '91
Box Qty. 15



465315

75547-16030
Yellow Plastic
Windshield Moulding Clip
Right
Toyota Tercel '83 - '88
Box Qty. 10

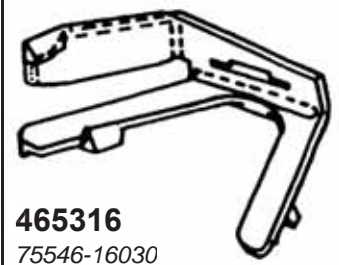

465316

75546-16030
White Plastic
Windshield Moulding Clip
Left
Toyota Tercel '83 - '88
Box Qty. 10



465317

75545-20060
Green Plastic
Windshield Moulding Clip
Toyota Celica '86 - UP
Box Qty. 25



465318

75546-20060
Blue Plastic
Windshield Moulding Clip
Toyota Celica '86 - UP
Box Qty. 25

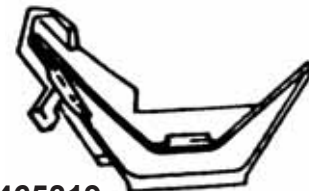

465319

75547-89105
Yellow Plastic
Windshield Chrome
Moulding Clip
Upper L.H. Corner
Toyota Truck '88 - UP
Box Qty. 10



465320

75545-89103
White Plastic
Windshield Chrome
Moulding Clip
Side L.H. & R.H.
without Center Tab
Toyota Truck '88 - UP
Box Qty. 15



465321

75547-89104
White Plastic
Windshield Chrome
Moulding Clip
Upper R.H. Corner
Toyota Truck '88 - UP
Box Qty. 10

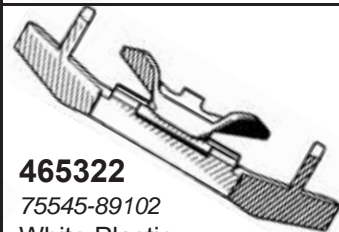

465322

75545-89102
White Plastic
Windshield Chrome
Moulding Clip
Side L.H. & R.H.
with Center Tab
Toyota Truck '88 - UP
Box Qty. 15



465323

75961-22030
Plastic
Windshield Moulding Clip
Top Corner R.H.
Toyota Cressida '88 - UP
Box Qty. 10



465324

75962-22040
Plastic
Windshield Moulding Clip
Top Corner
Toyota Cressida '88 - UP
Box Qty. 10

TOYOTA GLASS SHOP SUPPLIES

30 Toyota Clips



465325
75546-22060
Plastic
Windshield Sides
Moulding Clip
Toyota Cressida '88 - UP
Box Qty. 15



465326
75545-22070
Plastic
Windshield Top
Moulding Clip
Toyota Cressida '88 - UP
Box Qty. 15



465327
75547-89106
Black Plastic
Windshield Chrome
Moulding Clip
Lower R.H. Corner
Toyota Truck '88 - UP
Box Qty. 10



465328
75547-89107
Gray Plastic
Windshield Chrome
Moulding Clip
Lower L.H. Corner
Toyota Truck '88 - UP
Box Qty. 10



465329
75545-32030
Natural Nylon
Windshield Moulding Clip
Camry '92 - UP
Box Qty. 15



465330
75546-12060
White Plastic
Side Windshield
Moulding Clip
Toyota Corolla Sedan
& Wagon '88 - '92
Box Qty. 15



TOYOTA