



# CHRYSLER CLIPS

**27999 Box 25**



**28000**  
6031115, 9436175, 385189-S100  
Peel-Type Rivet  
Dia.: 1/4" Grip: 1/32" - 9/64"  
Flange Dia.: 1/2"  
Aluminum Rivet, Steel Mandrel  
Window Regulators  
GM, Ford, Chrysler '71 - UP  
Box Qty. 100

**28002 Box 25**



**28001**  
6031091, 9437938, 385323-S100  
Peel-Type Rivet  
Dia.: 1/4" Grip: 33/64" - 19/32"  
Flange Dia.: 1/2"  
Aluminum Rivet, Steel Mandrel  
Window Regulator  
GM, Ford, Chrysler '76 - UP  
Box Qty. 100



**38507**  
6032856  
Dia.: 1/8", Grip: 5/16" - 3/8"  
Flange Dia.: 3/8"  
Aluminum Rivet (Black)  
Aluminum Mandrel  
Body Side Moulding &  
Universal Applications  
Chrysler  
Box Qty. 25



**38525**  
9432137, 6032138  
Dia.: 5/32" Grip: 1/8" - 3/16"  
Flange Dia.: 5/16"  
Alum. Rivet, Steel Mandrel  
Countersunk Head  
Trunk Lock Swivel Emblem  
Chrysler, GM '73 - UP  
Box Qty. 25



**38550**  
9437486, 6032926  
Dia.: 1/4", Grip: 9/64" - 3/16"  
Head Dia.: 1/2"  
Alum. Rivet, Steel Mandrel  
Window Regulator Rivet  
G.M., Chrysler  
Box Qty. 25



**38516**  
6036148-AA  
Split-Type Rivet  
5/32" Dia., G.R.: 3/64"-1/4"  
Flange Diameter: 7/16"  
Aluminum Rivet (Black)  
Aluminum Mandrel  
Front Bumper, Trim Panel,  
Instrument Panel &  
Running Boards  
1999 - UP  
Box Qty. 25



**38555**  
389268-S100, 201843399,  
12338153  
Dia.: 1/4"  
Grip: 11/16" - 3/4"  
Flange Dia.: 1/2"  
Peel-Type Rivet  
Aluminum Rivet  
Steel Mandrel  
Window Regulators  
Ford & GM  
Box Qty. 25



**200170**  
367292 & 367291  
Chrome Plated Steel  
Outside Rearview Mirror  
1/4"-20 x 1" Bolt &  
Mounting Nut  
Chrys. & GM Trucks & Vans  
Box Qty. 10



**200175**  
367291,  
14007511  
Chrome Plated  
Steel Screw  
1/4"-20 x 1"  
Hex Washer Head  
Hex: 3/8"  
Wshr O.D.: 5/8"  
Truck Mirror Mounting  
Screw, Chrysler & GM  
Trucks/Vans  
Box Qty. 10



**200366**  
6509539-AA  
Phosphate  
Hex Head Sems®  
Tapping Screw  
M4.8-1.61 x 32mm  
(#10 x 1-1/4")  
Washer OD: 19mm (3/4")  
Hex: 8mm  
Chrysler Town & Country  
and Dodge Ram 2009 - 14  
Box Qty. 50



**216155**  
34201287, 8934201287  
Zinc  
M6-1.0 x 20mm  
Slotted Hex Washer  
Head, Body Bolt  
Wshr Hd O.D.:  
13mm (1/2")  
Hex: 10mm  
Chrysler, AMC  
Box Qty. 50



**266024**  
6506104AA  
Zinc & Yellow  
Roof Rack Nutsert  
w/ Sealer Under Head  
M6 - 1.0 Thread  
Head Dia.: 17mm  
Jeep '99 - 2001  
Box Qty. 10



**266025**  
6503812, 6504601  
Zinc & Yellow  
Wheel Opening  
Moulding Nutsert  
M5 - .8 Thread  
Head Dia.: 10mm  
Overall Length: 12mm  
Jeep '99 - UP  
Box Qty. 15



**270006**  
4806226-AA  
Zinc Front & Rear  
Bumper and Grille  
Fastener, #6 Screw Size  
Width: 10mm  
Overall Height: 18mm  
Buick Lucerne and Cadillac  
CTS & STS 2005 - UP  
300, Dodge Nitro and Jeep  
Commander 2005 - UP  
Box Qty. 15



**280040**  
8934-201-263,  
6000943  
Nylon  
Radiator Grille Nut  
#8 Screw Size  
AMC-Renault,  
Chrysler  
Box Qty. 50

# CHRYSLER CLIPS



**285036**  
6031869, 1264963,  
10032838,  
8934-201-602  
High Torque  
Screw Grommet  
GM, Chrysler,  
AMC-Renault '78 - UP  
Box Qty. 25



**280250**  
1386805, 6032676  
Nylon  
Radiator Grille Nut  
# 8 or # 10 Screw Size  
Chrysler Truck '85,  
Buick &  
General Purpose  
Box Qty. 100



**290000**  
55156879-AB  
Black Nylon  
Tail Light Grommet  
Head Size: 20mm x 31mm  
Receives 10mm Ball Stud  
Jeep Commander  
2006 - UP  
Box Qty. 25



**290001**  
6508072-AA  
Black Nylon  
Headlight Nylon Nut  
M5.5 (#12) Screw Size  
Head Size: 15mm x 15mm  
Stem Length: 10mm  
Fits In 10.5mm x 11mm  
Hole, Jeep Grand  
Cherokee & Commander  
2005 - UP  
Box Qty. 50



**290002**  
4805119  
Natural Nylon  
Cowl Vent Nut  
Screw Size: #10 (4.8mm)  
Chrysler LH, Neon & 300M  
98 - UP  
Box Qty. 25



**290005**  
6505161AA  
White Nylon  
Bumper Fascia  
Grommet  
Screw Size: M4.2 (#8)  
Hd Size: 14mm x 18mm  
Snaps Into  
9mm x 11mm Hole  
Chrysler LH &  
LHS Series '98 - UP  
Box Qty. 25



**290010**  
6504072  
Black Nylon  
Tail Light Housing  
Grommet  
Head Dia.: 16mm  
Stem Length: 10mm  
Snaps Into 12mm Hole  
Dodge Dakota,  
Ram Trucks  
'97 - UP  
Box Qty. 25



**290020**  
0152867  
Nylon  
Headlight Spacer Nut  
#8 Screw Size  
Chrysler '78 - UP  
Box Qty. 25



**290041**  
*OEM Not Available*  
Tail Light Assembly  
Grommet  
Head Dia: 19mm  
Stem Length: 11mm  
Dodge 2006 - UP  
Box Qty. 25



**290070**  
6031138  
Nylon  
Headlight Grommet  
Chrysler  
Box Qty. 50



**290080**  
6500725  
Black Nylon  
Headlamp Bezel Nut  
No. 10 Screw  
Chrysler "E" Class,  
LeBaron, New Yorker,  
Dodge 400-600 '83 - UP  
Box Qty. 50



**290090**  
6501699  
Plastic  
Cowl Screen Grommet  
Hole: M7 Square  
Screw: M4.2  
Chrysler Minivans &  
Various Cars '90 - UP  
Box Qty. 25



**303115**  
Zinc Plated  
Jack Nut  
Thread: M4-0.7  
Head Dia.: .468  
For .318 - .330 (5/16") Hole  
Chrysler, Jeep Tail Gates  
Box Qty. 25













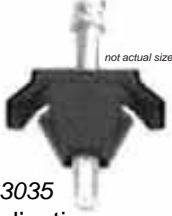

**303120**  
367292, 6031438  
Zinc w/ Sealer  
Outside Rear View  
Mirror Retainer  
Thread: 1/4-20  
GM & Chrysler  
Box Qty. 25



**350050**  
4762490  
Headlamp Adjuster  
Pivot Socket  
Hole: 12mm Square  
Chrysler '91 - '94  
Box Qty. 10



# CHRYSLER CLIPS

 <p><b>350080</b> 5201269, 5201359 4270581, 4334140, 1,2 Headlight Adjusting Nut &amp; Screw Assembly Screw: 12-28 x 2-1/8" Chrysler '78 - UP Box Qty. 25</p>	 <p><b>350085</b> 3868985, 4270582, 4270946, 5263035 Headlamp Adjusting Nut &amp; Screw Assembly Screw: 12-28 x 1-1/2" Chrysler Products '78-UP Diplomat &amp; LeBaron '78-UP "K" Bodies Box Qty. 10</p>	 <p><b>415040</b> 2988430 Black Nylon Radiator Grille Retainer Chrysler Box Qty. 25</p>	 <p><b>415072</b> Box 250 <b>415071</b> Box 500</p> <p><b>415070</b> 1605396, 6030441, 388577S Black Nylon Radiator Yolk, Fender &amp; Bumper Shield Retainer G.M. Cars, Ford, Chrysler Box Qty. 50</p>
 <p><b>415076</b> Box 250</p> <p><b>415075</b> 21094146, 6501301 Black Nylon Trim Panel Retainer GM Saturn '91 - UP Sliding Door &amp; Lift Gate Trim Panel Retainer Mini Vans '87 - UP Box Qty. 50</p>	 <p><b>415077</b> N807721-S, 6504043 Black Nylon Trim Panel Retainer Ford Explorer '93 - UP Trunk Lid Latch Chrysler '96 - UP Box Qty. 50</p>	 <p><b>415100</b> 20413107, 388246S, 4006516 Black Nylon Weatherstrip Fastener General Purpose GM, Ford, AMC Box Qty. 50</p>	 <p><b>415129</b> Box 50</p> <p><b>415126</b> N803421-S, 6501590 Black Nylon Splash Shield &amp; Fascia Retainer Head Dia.: 1" Panel Range: 1/8" Shoulder Dia.: 5/16" Fits Into 5/16" Hole Box Qty. 25</p>
 <p><b>415165</b> D30Z-16776-A 385330-S, 6003351 Black Nylon Hood Insulation Retainer Chrysler '72 - UP Grille to Radiator Retainer Ford '73 - UP Box Qty. 25</p>	 <p><b>415190</b> 2898909, 382570-S Black Nylon Dash &amp; Cowl Panel Retainer G.M., Chrysler, Ford '70 Box Qty. 50</p>	 <p><b>415221</b> Box 250 <b>415222</b> Box 500</p> <p><b>415220</b> 3977775, 3078511 Hood Insulation Clip Head Dia.: 2" Stem Length: 3/4" Stem Dia.: 5/16" GM '64 - UP Can be used on other cars Box Qty. 50</p>	 <p><b>415229</b> 6504098, N808842-S Black Nylon Hood Insulation Retainer Head Dia: 1-1/4" Stem Dia: 5/16" Stem Length: 11/16" Chrysler Sebring 96 - UP Ford Taurus, Sable &amp; Mark VIII 96 - UP Box Qty. 50</p>
 <p><b>415232</b> 4341060 Plastic Retainer Hood Insulation Head Dia.: 1-1/4" Chrysler '85 - UP Box Qty. 25</p>	 <p><b>415236</b> 6502842, 21039129 Black Nylon Hood Insulation Retainer Hole: 1/4" Head Dia.: 1-3/16" Chrysler Concorde, Dodge Intrepid, Eagle Vision '93 - UP GM Saturn '92 - UP Box Qty. 50</p>	 <p><b>415245</b> 4696488, 6503163 Black Nylon Push-Type Retainer Head Diameter: 1/2" Stem Length: 1-13/64" Fits Into 9/32" Hole 1987 - UP Box Qty. 25</p>	 <p><b>415251</b> 6502328 Black Nylon Door Weatherstrip Retainer Dodge Ram 1994 - UP Box Qty. 100</p>

# CHRYSLER CLIPS

17 Chrysler Clips

## 415254

4806110-AA  
 Push-Type Retainer  
 Head Diameter: 24mm  
 Shoulder Length: 3mm  
 Stem Length: 20mm  
 Fits Into 11mm Hole  
 Chrysler 300 & Magnum  
 2005 - UP  
 Box Qty. 15



## 415305

6502545  
 Nylon  
 Headlight Side  
 Shield Retainer  
 Dodge Daytona  
 '92 - UP  
 Box Qty. 25



## 415524

6507669-AA  
 Black Nylon  
 Radiator Grille  
 Push-Type Retainer  
 Head Dia: 20mm  
 Stem Length: 16mm  
 Fits Into 10mm Hole  
 Dodge Durango 2004 - UP  
 Box Qty. 25

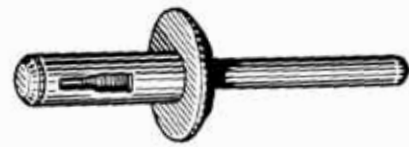

**415600.....Box 25**  
**415800.....Box 100**  
 20452072, N803862-S, 6501559  
 6.3mm Dia. Nylon Blind Rivet  
 Panel Range: 4mm to 10mm  
 Flange: 13mm  
 G.M., Ford, Chry., General Purpose

## 415601

4630088  
 Super Tough Black Nylon  
 Blind Rivet  
 Countersunk Head  
 Hole: M6.3, Flange: 17mm  
 G.R.: .7 - 4.5mm  
 Shoulder: 2.0mm  
 Exterior Mouldings,  
 Body Side Mldg Attachment  
 Dodge & Eagle  
 Chrysler "LH" Models '93 - UP  
 Box Qty. 25



**415602.....Box 25**  
**415802.....Box 100**  
 14063981, N803043-S, 6500911  
 6.3mm Dia. Nylon Blind Rivet  
 Panel Range: 4mm to 10mm  
 Flange: 17mm  
 G.M., Ford, Chry., General Purpose



## 415603

46300660  
 Super Tough Black Nylon  
 Countersunk Blind Rivet  
 Hole: M6.3, Head: 17mm  
 G.R.: .7 - 4.9mm  
 Shoulder: 9mm x 2mm  
 Exterior Mouldings  
 Chrysler "LH" '93 - UP  
 Box Qty. 15



## 415604

6500859  
 Super Tough Black Nylon  
 Blind Rivet w/ Shoulder  
 Hole: M5, Head: 12mm  
 G.R.: 3.0 - 4.5mm  
 Chrysler  
 Box Qty. 25

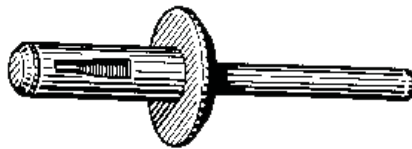

## 415605

6501509  
 Super Tough Black Nylon  
 Blind Rivet w/ Shoulder  
 Hole: M6.3, Head: 17mm  
 G.R.: 1.0 - 5.0mm  
 Countersunk Shoulder: 4.5mm  
 Body Side Mouldings  
 Chrysler "LH" '93 - UP  
 Various Models '87 - UP  
 Box Qty. 25



**415610.....Box 25**  
**415810.....Box 100**  
 20421672  
 6.63mm Dia. Nylon Blind Rivet  
 Panel Range: 2.5mm to 5mm  
 Flange: 13mm  
 G.M., General Purpose

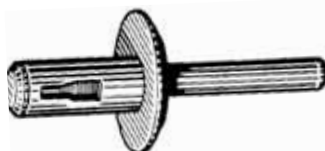

**415620.....Box 25**  
**415820.....Box 100**  
 20433026, 175-853-577A  
 6.63mm Dia. Nylon Blind Rivet  
 Panel Range: 2.5mm to 5mm  
 Flange: 18mm  
 G.M., VW, General Purpose



**415630.....Box 25**  
**415830.....Box 100**  
 6500898  
 5mm Dia. Nylon Blind Rivet  
 Panel Range: 6mm to 10mm  
 Flange: 12mm  
 Chrysler, General Purpose

# CHRYSLER CLIPS

 <p><b>415640</b>.....<b>Box 25</b>  <b>415840</b>.....<b>Box 100</b>            20432975, 175-853-57701C            5mm Dia. Nylon Blind Rivet            Panel Range: 3mm to 6mm            Flange: 12mm            G.M., VW, General Purpose</p>	 <p><b>415652</b>            6503106            Drive Type Rivet Lower Rear Moulding            Hole: M6.3            Head: 22mm            Chrysler "LH"            Models '93 - UP            Jeep Grand Cherokee, Laredo '94 - UP            Box Qty. 15</p>	 <p><b>415664</b> <i>Box 100</i>  <b>415663</b>            16500308, 6500787            Black Nylon Tail Light Retainer            Fits Into 3/16" Hole            GM, Chrysler            Box Qty. 25</p>	 <p><b>415759</b> <i>Box 50</i>  <b>415761</b>            58974-0008, 89421-80270            Nylon Grille Clip            13mm Wide            22mm Long            Toyota, Mitsubishi, Honda, Plymouth Laser, Isuzu, Ford Escort            Box Qty. 25</p>
 <p><b>415781</b> <i>Box 100</i>  <b>415780</b>            10053182            Screw Type Rivet            Body Splash Shield            Hole: M8 Flange: 15mm            P.R.: 2-10mm            GM "W" Body '88 - UP            GM "J" '95 - UP            Box Qty. 25</p>	 <p><b>415785</b>            10140480, 6502625            Black Nylon Push-Type Retainer            Head Dia.: 21mm (27/32")            Panel Range: 3mm (1/8")            Stem Length: 25mm (1")            Fits Into 12mm (1/2") Hole            G.M., Chrysler            Box Qty. 25</p>	 <p><b>415790</b>            6501544, N803170-S            Nylon Retainer            Hole: M5            Head: 10mm            Ford Mustang, Capri '84 - UP            Chrysler Imports            Box Qty. 50</p>	 <p><b>415851</b>            6502573            Nylon Push Type Retainer            Cowl Screen Attachment            Head Size: 15/32"            Stem Length: 9/16"            Fits Into 1/4" Square Hole            Chrysler Concorde &amp; LHS            Dodge Intrepid            Eagle Vision '93 - UP            Box Qty. 15</p>
 <p><b>415881</b>            Black Nylon            Cowl Screen Retainer            Chrysler New Yorker, LHS, Dodge Intrepid            Eagle Concorde &amp; Vision '93 - UP            Box Qty. 15</p>	 <p><b>415893</b>            21077123, 6509103AA, W705436-S300            Black Nylon Wheel Opening Mldg Push-Type Retainer            Head Dia: 19/32" (15mm)            Stem Length: 3/4" (19mm)            Fits Into 1/4" (6mm) Hole            Saturn 91 - UP, Ford 2002 - UP, Chrysler 2010 - UP            Box Qty. 25</p>	 <p><i>not actual size</i>  <b>415991</b>            4630253            Rear Fascia Push Type Retainer            Head Size: 7/8" x 1-25/32"            Stem length: 1-1/16"            Fits Into 1/2" Hole            Chrysler Concorde &amp; LHS            Dodge Intrepid            Eagle Vision '93 - UP            Box Qty. 15</p>	
 <p><b>415992</b>            4001916            Black Nylon Weatherstrip Retainer            Hole: 5/16"            Head: 3/16" x 9/16"            P.R.: .050            Jeep &amp; GM Trucks            Box Qty. 50</p>	 <p><b>415994</b>            4696129            21077575            Weatherstrip Retainer            Front and Rear Doors            Hole: M5            Head: 6.5 x 16.5mm            P.R.: 1.5mm            Chrysler "LH" Models '93 - UP            Box Qty. 100</p>	 <p><b>416040</b>            6503453            Black Nylon Fascia To Bumper Push Type Ret.            Head Dia.: 1"            Stem length: 1-1/8"            Fits Into 1/4" Hole            Jeep Grand Cherokee '94 - UP            Box Qty. 25</p>	 <p><b>416047</b>            390018-S, 6033082            10121502, 6033840            Black Nylon Shield Retainer            Battery Post Shield, Engine Splash Shield            Radiator Side Air Baffle            Head Dia.: 11/16"            Stem Dia.: 5/16"            Stem Length: 1-1/16"            Ford, GM '89 - UP            Box Qty. 50</p>

# CHRYSLER CLIPS

17 Chrysler Clips

## 416055

MB888869,  
90505-SLO-003,  
90467-08155  
Plastic  
Bumper Cover  
Screw-Type Rivet  
Hole: M8, Stem: 20.5mm  
Panel: 13mm, HD: 20mm  
Chrysler, Mitsubishi,  
Acura, Toyota  
'93 - UP  
Box Qty. 15



## 416057

6504521  
Black Nylon  
Fascia Push Type  
Retainer  
Head Dia.: 23/32"  
Stem Length: 29/32"  
Fits into 5/16" Hole  
Chrysler LHS,  
Concorde,  
Dodge Intrepid &  
Eagle Vision '98 - UP  
Box Qty. 25



## 416060

4676356  
Radiator Grille Retainer  
Chrysler Minivan  
'96 - UP  
Box Qty. 25



## 416097

MR138807  
Bumper Cover  
Screw Type Rivet  
Hole: M8, Flange: 20mm  
Max G.R.: 20mm  
Chrysler Sebring '96 - UP  
Mitsubishi Eclipse '94 - UP  
Box Qty. 5



## 416102

6503819,  
6503401  
Black Nylon  
M7.5 x 35mm  
Square Drive  
Truss Head  
Tapping Screw  
Head Dia.: 22mm  
Shoulder Dia.: 9mm  
Foam To Bumper Fascia  
Chrysler '93 - UP  
Box Qty. 15



## 416123

Black Nylon  
Bumper Cover  
Push-Type  
Retainer  
Top Hd Dia: 15mm  
Bottom Hd Dia: 14mm  
Stem Length: 12mm  
Fits Into 7mm Hole  
Sebring & Stratus  
2000 - UP  
Box Qty. 15



## 416125

Black Rubber  
Bumper Cover &  
Garnish Moulding  
Grommet  
With Sealer  
Head Dia: 16mm  
Stem Length: 20mm  
Fits Into 9mm Hole  
Sebring & Stratus  
2000 - UP  
Box Qty. 15



## 416138

Black Nylon  
Shroud Retainer  
High Retention Capability  
GM, Ford, Chrysler  
Box Qty. 50



## 416140

22547243,  
6501916  
Black Nylon  
Splash Shield &  
Wheel Well Cover  
Retainer  
Chrysler '88 - UP  
Hood Seal Retainer  
GM '89 - UP  
Box Qty. 50



## 416144

6031383  
Nylon  
Grille Retainer  
Chrysler '78 - UP  
Box Qty. 25



## 416146

6501925, 10134407  
Push Type  
Retainer  
Head Size: 11/16"  
Stem Length: 13/16"  
Fits Into 1/4" Hole  
Chrysler Concorde  
Dodge Intrepid  
Eagle Vision '93 - UP  
Coolant Recovery Res.  
GM '92 - UP  
Box Qty. 25



## 416148

6503339  
(Use w/ #416150)  
Black Nylon  
Cowl Top Stud  
Retainer Cover  
Torx Recess  
Head Dia.: 13/16"  
Dodge Ram '94 - UP  
Jeep Grand Cherokee  
'99 - UP  
Box Qty. 25



## 416150

6503336, 6503338  
(Use w/ #416148)  
Black Nylon  
Cowl Screen Retainer  
Flange Dia.: 9/16"  
Stem Dia.: 19/64"  
Stem Length: 13/32"  
Dodge Ram '94 - UP  
Jeep Grand Cherokee  
'99 - UP  
Box Qty. 25

















## 416152

25535963,  
N811772-S  
Plastic-Twist Lock  
Site Shield &  
H/L Shroud Cover Retainer  
GM "C", "H" & "N" Bodies  
'94 - '96  
Ford Full Size  
Lincoln Town Car '98 - UP  
Box Qty. 15



[www.srfast.com](http://www.srfast.com)

# CHRYSLER CLIPS

<p><b>416154</b> 4805405AA Front Fascia Drive Type Rivet Hole: M8.5, Flange: 34mm P.R.: .5 - 2.0mm Shoulder: 3.5 x 11mm Chrysler Concorde Dodge Intrepid, 300M '98 - UP Box Qty. 15</p> 	<p><b>416155</b> 4389947-AA Bumper Cover Ret. w/ Sealer Head Dia: 24mm Shoulder Length: 3mm Stem Length: 20mm Fits Into 11mm Hole Chrysler Avenger, Journey &amp; Sebring 2008 - UP Box Qty. 15</p> 	<p><b>416171</b> 15056810, 6505686AA Black Nylon Bumper Fascia Retainer Head Dia.: 25mm Stem Dia.: 13mm Stem Length: 15mm GM, Chrysler 2002 - UP Box Qty. 25</p> 	
<p><b>416172</b> 4857345-AA Black Nylon Tail Light Housing Retainer Lg Head Dia.: 21mm Stem Length: 23mm Fits Into 9.5mm Hole Chrysler Caravan, T&amp;C, Voyager 2002 - UP Box Qty. 25</p> 	<p><b>416179</b> 6506132-AA Black Nylon Side Radiator Shield Retainer Head Dia.: 20mm Stem Length: 17mm Fits Into 7mm Hole Chrysler Sebring, Stratus '2001 - UP Box Qty. 25</p> 	<p><b>416181</b> WX68DX9-AA Black Nylon Door Trim Panel Retainer Head Dia.: 22mm Stem Length: 10mm Fits Into 9mm Hole Chrysler 300, Dodge Magnum 2005 Box Qty. 25</p> 	<p><small>not actual size</small></p> <p><b>416182</b> 55157112-AA, -AB Black &amp; Natural Nylon Bumper Cover Retainer Head Size: 25mm x 45mm Shoulder Length: 3mm Stem Length: 20mm Fits Into 9.5mm Hole Jeep Liberty 2005 - UP Box Qty. 15</p> 
<p><b>416183</b> OWX68BD-AA Gray Nylon Door Trim Panel Retainer Head Dia.: 22mm Stem Length: 10mm Fits Into 9mm Hole Chrysler Charger, 300M, Dodge Magnum 2005 Box Qty. 25</p> 	<p><b>416184</b> 11561368, 6508712AA Black Nylon Fender, Wheel &amp; Bumper Retainer Head Dia.: 18mm Stem Length: 20mm P.R.: 3mm - 5.8mm Fits Into 9.5mm Hole GM, Chrysler Box Qty. 15</p> 	<p><b>416187</b> OWX68BD1-AA Tan Nylon Door Trim Panel Retainer Head Dia.: 22mm Stem Length: 10mm Fits Into 9mm Hole Chrysler Charger, 300M, Dodge Magnum 2005 Box Qty. 25</p> 	<p><b>416190</b> 06508863AA, 11589289 Black Nylon Air Defroster/ Windshield Defroster Push-Type Retainer Head Dia.: 18mm Stem Length: 17.5mm PR: 2.0mm - 4.5mm Fits Into 6.5mm Hole GM, Chrysler Box Qty. 25</p> 
<p><b>416196</b> 05116530AA, 15296830 Black Nylon Fascia/General Purpose Push-Type Retainer Head Dia.: 19mm Stem Length: 16mm PR: 5.0mm - 7.0mm Fits Into 8mm Hole GM, Chrysler Box Qty. 25</p> 	<p><b>416206</b> 6509960AA Black Nylon Bumper Push-Type Retainer Head Dia: 18mm Stem Length: 10mm Fits Into 8mm Hole Chrysler 300 2011 - UP Box Qty. 25</p> 	<p><b>416207</b> 6509590-AA Black Nylon Bumper Retainer Head Dia: 19mm Stem Dia: 8mm Stem Length: 26mm Chrysler 300 &amp; Charger 2011 - UP Box Qty. 25</p> 	<p><b>416208</b> W712665-S300, 11589295 Black Nylon Fender, Flare, Gas Tank &amp; Panel Attchmnt Push-Type Ret. Head Dia.: 25mm Stem Length: 20mm PR: 3.0mm - 6.0mm Fits Into 10.5mm Hole GM, Ford, Chrysler Box Qty. 15</p> 

17 Chrysler Clips

# CHRYSLER CLIPS

## 416261

*N/A From O.E.M.*  
Black Nylon  
M14 x 34mm  
Bumper and Door Insulator  
Nylon Screw  
22mm Head O.D.  
No. 3 Square Drive  
Fits Into 12mm Hole  
2005 - On  
Box Qty. 25



## 416273

55055098  
Black Nylon  
Head light Grille  
Retaining Clip  
Dodge Ram 1994 – Up  
Box Qty. 25



## 416274

4806334-AA  
Rear Bumper  
Push-Type  
Retainer With Sealer  
Head Dia: 34mm  
Shoulder Length: 3.5mm  
Stem Length: 17mm  
Fits In 8.5mm Hole  
Dodge Caliber, Jeep  
Compass & Patriot '07-UP  
Box Qty. 10



## 416275

5160260-AA  
Black Nylon  
Rear Bumper  
And Fender  
Push-Type Retainer  
Bottom Head Dia: 18mm  
Stem Length: 20mm  
Fits Into 8mm Hole  
Dodge Caliber and  
Jeep Compass & Patriot  
2007 - UP  
Box Qty. 15



## 416276

6508197-AA,  
W706092-S300  
Black Nylon  
Front Air Shield,  
Splash Guard &  
Heat Shield  
Push-Type Retainer  
Head Diameter: 18mm  
Stem Length: 18mm  
Fits Into 6.4mm Hole  
Dodge Ram 2006 - UP  
Ford Taurus 2008 - UP  
Box Qty. 25



## 416277

6501067  
Black Nylon  
Fascia Retainer  
Chrysler 1985 - UP  
Box Qty. 50



## 416322

68033045AA  
Black Nylon  
Front & Rear Fender Flare  
Retainer  
Head Diameter: 20mm  
Stem Length: 19mm  
Fits Into 9mm Hole  
Jeep Wrangler 2007 - UP  
Box Qty. 15



## 430000

55157070-AC  
Black Nylon  
Rocker Moulding Clip  
Head Diameter: 25mm  
Overall Length: 31mm  
Fits Into 8mm Hole  
Jeep Liberty  
2002 - On  
Box Qty. 10



## 430001

1BA41AX1-AA  
Black Nylon  
Rocker Panel  
Moulding Clip  
Head Size: 12mm x 20mm  
Stem Length: 13mm  
Chrysler 300  
Dodge Magnum 2005 - UP  
Box Qty. 15



## 430002

55157069-AB  
White Nylon  
Rocker Moulding Clip  
Top Head Size:  
14mm x 27mm  
Bottom Head Size:  
13mm x 26mm  
Stem Length: 15mm  
Fits Into 9mm Hole  
Jeep Liberty 2002 - UP  
Box Qty. 25



## 430003

55157055-AA,  
55157065-AA  
Fender Flare  
Moulding Clip  
Top Head Size:  
14mm x 38mm  
Bottom Head Size:  
16mm x 38mm  
Stem Length: 15mm  
Fits Into 9mm Hole  
Jeep Liberty 2005 - UP  
Box Qty. 15



## 430004

1BA41XWG-AA  
Rocker Panel  
Moulding Clip  
Head Size:  
12mm x 20mm  
Stem Length: 13mm  
Fits Into 9mm Hole  
Chrysler 300 2006 - UP  
Box Qty. 15



## 430005

5189181-AA  
Front Fender Flare (Rear)  
Moulding Clip With Sealer  
Top Head Size:  
14mm x 40mm  
Bottom Head Size:  
14mm x 18mm  
Stem Length: 15mm  
Jeep Commander 2006-UP  
Box Qty. 10



## 430006

6508947-AA  
Front Bumper  
Moulding Clip  
Top Head Size:  
11mm x 32mm  
Bottom Head Size:  
15mm x 20mm  
Stem Length: 20mm  
Fits Into 15mm Hole  
Jeep Patriot 2007 - UP  
Box Qty. 10



## 430007

*Not Available From O.E.M.*  
Fender & Wheel Flare  
Moulding Clip  
Top Head Size:  
14mm x 18mm  
Bottom Head Size:  
17mm x 21mm  
Stem Length: 13mm  
Fits Into 9mm Hole  
Jeep Commander  
2006 - UP  
Box Qty. 25



## 430008

5189180-AA  
Front Fender  
Moulding Clip  
Top Head Size:  
13mm x 31mm  
Bottom Head Size:  
14mm x 22mm  
Stem Length: 22mm  
Jeep Commander  
2006 - UP  
Box Qty. 15









# CHRYSLER CLIPS











<p><b>430009</b> 6509288AA Black Nylon Rocker Clip with Sealer Upper Head Size: 21mm x 22mm Bottom Head Size: 22mm x 22mm Stem Length: 9mm Grand Caravan and Town &amp; Country 2008 - UP Box Qty. 10</p> 	<p><b>430010</b> White Nylon Rocker Panel Moulding Clip Top Head Size: 9/16" x 13/16" Bottom Hd Size: 9/16" x 23/32" Stem Length: 5/8" Dodge Dakota &amp; Durango and Jeep Liberty 2000 - UP Box Qty. 15</p> 	<p><b>430011</b> 68225214AA White Nylon Moulding Clip Head Size: 11.5mm x 21mm Stem Length: 11mm Overall Height: 17mm Jeep Cherokee 2014 - UP Box Qty. 50</p> 	<p><b>430090</b> 6003219 Side Moulding Clip Chrysler Cars &amp; Trucks '71 - UP Box Qty. 25</p> 
<p><b>430095</b> 5FR56DX9 Plastic Rocker Moulding Retainer Hole: M11 Square Head: 11 x 20mm Jeep Grand Cherokee '99 - UP Box Qty. 15</p> 	<p><b>430240</b> 6003632 Fender Wheel House Moulding Clip Chrysler Products '77-UP Box Qty. 50</p> 	<p><b>430290</b> 6003685 Quarter Panel Outside Moulding Clip Chrysler Products '78 - UP Box Qty. 10</p> <p><small>not actual size</small></p> 	<p><b>430480</b> 6003856 Deck Lid Moulding Clip Dodge Van '84 - UP Box Qty. 25</p> 
<p><b>430482</b> 55156429-AA Rocker Panel &amp; Bumper Fascia Retainer Top Head Size: 1/2" x 1-3/16" Stem Length: 27/32" Liberty '2002 - UP Box Qty. 10</p> 	<p><b>430485</b> Fender Flare Retainer Hole: M10 Jeep Liberty 2002 Box Qty. 10</p> 	<p><b>445032</b> 385661-S, 6003349, 6032363, N989022 Black Nylon Door Trim Panel Retainer Ford, Chrysler, VW '75 - UP Box Qty. 25</p> 	<p><b>445038</b> (Use With #445039) White Nylon Door Panel Ret. Top Head Dia.: 13mm Bottom Head Dia.: 23mm Stem Dia.: 6.5mm Stem Length: 20mm Chrysler LH Series 2000 - 2001 Box Qty. 25</p> 
<p><b>445039</b> (Use With #445038) White Nylon Door Panel Grommet Head Dia.: 19mm Stem Length: 12mm Fits Into 9mm Hole Chrysler LH Series 2000 - 2001 Box Qty. 25</p> 	<p><b>445040</b> White Nylon Door Trim Panel Retainer w/Sealer Small Hd Dia.: 13mm Large Hd Dia.: 18mm Stem Dia.: 8mm Stem Length: 18mm Chrysler Minivans '99 - '2000 Box Qty. 15</p> 	<p><b>445042</b> MB566719 Plastic Door Cladding Retainer Hole: M7 Head: 12mm P.R.: 2mm Chrysler Sebring, Concorde &amp; Eagle Talon '96 - UP Box Qty. 15</p> 	<p><b>445044</b> 6505539AA Plastic Door Panel Retainer (Used On Plastic Panels) Hole: M7, Head: 15mm P.R.: 1.7 - 2.25mm Jeep Grand Cherokee '99 - UP Box Qty. 25</p> 

# CHRYSLER CLIPS

17 Chrysler Clips

 <p><b>445046</b> 6503709 Plastic-Natural Door &amp; Quarter Trim Panel Retainer Hole: 5/16" G.R.: 1/16" - 9/16" Minivans, Pick-ups Sebring Convertible Dodge Viper '94 - UP Box Qty. 50</p>	<p><b>Upholstery And Trim Clips</b> 5mm Hole Size Chrysler Products, Japanese Models, Mitsubishi Models Box Qty. 25</p>  <table border="0"> <thead> <tr> <th>Part No.</th> <th>OEM No.</th> <th>Color</th> </tr> </thead> <tbody> <tr> <td><b>445178</b></td> <td>MB178893</td> <td>Black</td> </tr> <tr> <td><b>445180</b></td> <td>MB222647</td> <td>Burgundy</td> </tr> <tr> <td><b>445182</b></td> <td>MB178894</td> <td>Blue</td> </tr> <tr> <td><b>445184</b></td> <td>MB178899</td> <td>Off White</td> </tr> <tr> <td><b>445186</b></td> <td>MB178896</td> <td>Lt. Blue</td> </tr> </tbody> </table>		Part No.	OEM No.	Color	<b>445178</b>	MB178893	Black	<b>445180</b>	MB222647	Burgundy	<b>445182</b>	MB178894	Blue	<b>445184</b>	MB178899	Off White	<b>445186</b>	MB178896	Lt. Blue	
Part No.	OEM No.	Color																			
<b>445178</b>	MB178893	Black																			
<b>445180</b>	MB222647	Burgundy																			
<b>445182</b>	MB178894	Blue																			
<b>445184</b>	MB178899	Off White																			
<b>445186</b>	MB178896	Lt. Blue																			
 <p><b>445350</b> 4114785 Zinc Plated Trim Panel Retainer Chrysler Products '86 - UP Box Qty. 50</p>	 <p><b>445585</b> 6003349, 9685057, 4005470, N98905101 White Nylon Door Trim Panel Retainer Chrysler, GM, AMC, VW '76 - UP Box Qty. 50</p>	 <p><b>445623</b> 20298365, 6013122 Natural Nylon Trim Panel Retainer GM '82 - UP Chrysler '76 - UP Box Qty. 50</p>	<p><b>445635 Box 50</b></p>  <p><b>445624</b> 6033862, 796255, 4005099, 0501094C1 Black Nylon Door Panel Retainer Hole: 1/4" AMC '76 - UP GM '81 - '88 Jeep Wrangler '91 - UP Box Qty. 25</p>																		
 <p><b>445632</b> 6502991 Yellow Nylon Trim Panel Retainer Tail Gate &amp; Trim Panel Jeep Cherokee '93 - UP Box Qty. 25</p>	 <p><b>445760</b> 385188-S, 6032235 Door &amp; Interior Trim Panel Retainer Ford '75 Chrysler '81 Box Qty. 50</p>	 <p><b>445785</b> OH452KD5 Nylon Quartz Matte Finish Head Dia.: 1-1/4" Stem Length: 7/16" Fits Into 1/4" Hole Dodge Caravan &amp; Plymouth Voyager '84 - UP Box Qty. 10</p>	 <p><b>445792</b> 6034336, 6034812, 6035807 Phosphate Door Panel Nut #6 Screw Size Chrysler Cirrus, Concorde, LHS, Dodge Intrepid, Stratus &amp; Eagle Vision '93 - UP Box Qty. 25</p>																		
 <p><b>445797</b> 6505292AA Natural Nylon Door Trim Panel Retainer Chrysler Vans '98 - UP Box Qty. 25</p>	 <p><b>445882</b> 6504014, 6503896, 6542907 White Nylon Door Panel Retainer Hole: M6.7 Chrysler Neon, Cirrus, Caravan, Stratus &amp; Voyager '95 - UP Dodge Pick-Up '94 - UP Box Qty. 100</p>	 <p><b>445883</b> 91560-SM4-003, 6502907 Plastic Front Door Trim Panel Retainer Hole Size: 8mm Honda Accord '90 - UP Dodge Pick-ups '94 - UP Box Qty. 25</p>	 <p><b>445890</b> 6503204 Green Nylon Trim Panel Retainer Hole: M7 Stem Length: 15mm Panel Thickness: 2mm Chrysler '95 - UP Box Qty. 50</p>																		

# CHRYSLER GLASS SHOP SUPPLIES

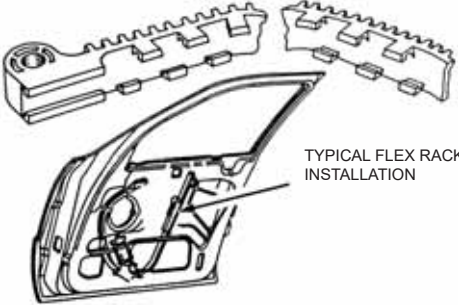
<p><b>475075</b> 4805570-AA Black Radiator Grille Cover Clip Width: 26mm Length: 26mm Caravan, Town &amp; Country and Voyager Mini-Vans '96- UP Box Qty. 10</p> 	<p><b>475155</b> 14083173, 17988488, 17997722, 25536302, N803685-S Frt Bumper, Side/High Stop Lamps, Rear Wheel Flare &amp; Int. Trim/Dash Mounting Nut Screw: M4.2 (#8) Hole: 9 x 11mm GM, Saturn, Hummer, Ford, Jeep '82 - UP Box Qty. 25</p> 	<p><b>460000</b> 3767196 Windshield Setting Block Lower Spacer Chrysler Caravan, Plymouth Voyager, Town &amp; Country '84 - UP Box Qty. 15</p> 	<p><b>460110</b> 6003238 Windshield Reveal Moulding Clip Chrysler Box Qty. 50</p> 
<p><b>460140</b> 6003301 Windshield Reveal Moulding Clip (Upper) Dodge Trucks '72 - UP Box Qty. 50</p> 	<p><b>471200</b> Windshield Wiper Linkage Cap Groove Dia.: 9/16" Chrysler Products '74 - UP Box Qty. 50</p> 	<p><b>480487</b> Black Filler Strip Windshield GM "J" Cars, GM "S" Trucks, Chrysler Mini-Van 1 Roll (100 Ft.)</p> 	<p><b>480515</b> 4339372 Door Glass Slide Guide w/Rivets Chrysler: LeBaron GTS, Dodge Lancer Box Qty. 25</p> 
	<p><b>480531</b> 69951-12180 Nylon w/ Steel Threaded Insert Glass Mount M6-1.0 Thread Ford, Nissan and Imports Box Qty. 5</p> <p>not actual size</p> 	<p><b>486015</b> Torque Pin Kit For Window Gears Ford &amp; Chrysler '64 - UP Box Qty. 15 pins</p> 	<p><b>486050</b> Power Window Regulator Gear (9-Tooth) Chrysler Products '75 - UP Box Qty. 1</p> <p>not actual size</p> 
<p><b>486110</b> Flex Rack, Used on Flex-Drive Window Regulators O/L 54", Cut to Fit Chrysler Products Box Qty. 1</p>  <p>TYPICAL FLEX RACK INSTALLATION</p>	<p><b>495250</b> 37601031 Door Lock Rod End Clip L.H. Chrysler Products Omni &amp; Horizon '78 - UP Box Qty. 50</p> 